

Air Force Institute of Technology

AFIT Scholar

---

Theses and Dissertations

Student Graduate Works

---

3-23-2009

## Methodology for Value-Driven Enterprise Architecture Development Goals: Application to DoDAF Framework

Justin W. Osgood

Follow this and additional works at: <https://scholar.afit.edu/etd>



Part of the [Computer and Systems Architecture Commons](#)

---

### Recommended Citation

Osgood, Justin W., "Methodology for Value-Driven Enterprise Architecture Development Goals: Application to DoDAF Framework" (2009). *Theses and Dissertations*. 2595.

<https://scholar.afit.edu/etd/2595>

This Thesis is brought to you for free and open access by the Student Graduate Works at AFIT Scholar. It has been accepted for inclusion in Theses and Dissertations by an authorized administrator of AFIT Scholar. For more information, please contact [richard.mansfield@afit.edu](mailto:richard.mansfield@afit.edu).



**METHODOLOGY FOR VALUE-DRIVEN  
ENTERPRISE ARCHITECTURE  
DEVELOPMENT GOALS: APPLICATION TO  
DODAF FRAMEWORK**

THESIS

Justin W. Osgood, Captain, USAF

AFIT/GEM/ENV/09-M16

**DEPARTMENT OF THE AIR FORCE  
AIR UNIVERSITY**

**AIR FORCE INSTITUTE OF TECHNOLOGY**

**Wright-Patterson Air Force Base, Ohio**

APPROVED FOR PUBLIC RELEASE; DISTRIBUTION UNLIMITED

The views expressed in this thesis are those of the author and do not reflect the official policy or position of the United States Air Force, Department of Defense, or the United States Government.

AFIT/GEM/ENV/09-M16

METHODOLOGY FOR VALUE-DRIVEN ENTERPRISE ARCHITECTURE  
DEVELOPMENT GOALS: APPLICATION TO DODAF FRAMEWORK

THESIS

Presented to the Faculty

Department of Systems and Engineering Management

Graduate School of Engineering and Management

Air Force Institute of Technology

Air University

Air Education and Training Command

In Partial Fulfillment of the Requirements for the  
Degree of Master of Science in Engineering Management

Justin W Osgood, BS

Captain, USAF

March 2009

APPROVED FOR PUBLIC RELEASE; DISTRIBUTION UNLIMITED.

METHODOLOGY FOR VALUE-DRIVEN ENTERPRISE ARCHITECTURE  
DEVELOPMENT GOALS: APPLICATION TO DODAF FRAMEWORK

Justin W Osgood, BS  
Captain, USAF

Approved:

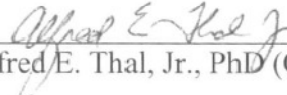
  
\_\_\_\_\_  
Alfred E. Thal, Jr., PhD (Co-Chairman)

23 MAR 2009  
Date

  
\_\_\_\_\_  
Jeffrey D. Havlicek, Maj, USAF (Co-Chairman)

23 MAR 09  
Date

  
\_\_\_\_\_  
Stephen P. Chambal, Lt Col, USAF (Member)

23 MAR 09  
Date

## Abstract

The Department of Defense Architectural Framework (DoDAF) describes 29 distinct views but offers limited guidance on view selection to meet system needs. This research extends the Value-Driven Enterprise Architecture Score (VDEA-Score) from a descriptive, evaluation protocol toward a prescriptive one by evaluating each DoDAF view and its contribution to the overall objective of the completed architecture. This extension of VDEA is referred to as VDEA-Development Goals (VDEA-DG). The program manager or other decision-makers may use this insight to justify the allocation of resources to the development of specific architecture views considered to provide maximum value. This research provides insight into the Joint Capabilities Integration and Development System (JCIDS) process and policy requirements. Existing guidance of a static list of views prior to DoD milestone approval detracts from the creation of vital architecture for system success. This research shows overlap between the most important views for the considered architecture project and the JCIDS requirements and identifies areas for JCIDS policy improvement. This research also identifies areas where DoDAF does not directly support the creation of capabilities. With additional information on the resources required for creating individual views, the tool could be expanded to identify an optimal build sequence given resource constraints.

## Acknowledgments

First, I would like to thank Major Garry Haase, Captain Craig Mills and Mr. Larry Cotton for their efforts in conducting this research. This thesis represents only a portion of a larger work and would have never happened if it were not for them.

I would like to thank my committee, Dr. Alfred E. Thal Jr., Major Jeffrey Havlicek, and Lt Col Stephen Chambal, for the advice and encouragement they provided me throughout the process. I would have been lost without their guidance.

To the men and women of the 642nd Electronic Systems Squadron, I appreciate the support and cooperation, and I am grateful for the opportunity they have provided me in working with them on this project.

To the class of GEM-09M, I'm grateful for the laughs and goods times as well as the opportunity to learn and grow alongside them.

Lastly, I'm eternally grateful for the love and support of my Natty Lite. I could not have done it without you there by my side.

Justin Osgood

## Table of Contents

	Page
<b>Abstract</b> .....	<b>iv</b>
<b>Acknowledgments</b> .....	<b>v</b>
<b>List of Figures</b> .....	<b>viii</b>
<b>List of Tables</b> .....	<b>ix</b>
<b>Chapter 1. Introduction</b> .....	<b>1</b>
1.1. Background .....	1
1.2. Research Questions .....	3
1.3. Methodology .....	4
1.4. Assumptions and Limitations .....	5
1.5. Significance of Study .....	6
1.6. Overview of Remaining Chapters.....	7
<b>Chapter 2. Literature Review</b> .....	<b>8</b>
2.1. Joint Force Protection .....	8
2.2. Fundamentals of Architecture and the DoDAF .....	9
2.3. Evaluation of Architecture and DoDAF .....	15
2.4. Value-Focused Thinking (VFT) .....	17
2.4.1. Benefits of Value-Focused Thinking.....	18
2.4.2. Previous Application of VFT in DoD.....	19
2.5. Measuring Value.....	20
2.5.1. Assessing the Value of U.S. Army International Activities .....	22
2.5.1.1. Overview of research .....	23
2.5.1.2. Similarity to VFT.....	24
2.5.2. Resource Value in Effects-Based Operations .....	25
<b>Chapter 3. Methodology</b> .....	<b>27</b>
3.1. Data Collection .....	28
3.2. Ways to Means Analysis.....	30
3.2.1. Create Matrix and Identify Relationships .....	30
3.2.2. Describe Relationships.....	31
3.3. Analysis.....	31
3.3.1. View Analysis.....	31
3.3.2. Build Sequence .....	32
3.4. Limitations .....	33



	Page
<b>Chapter 4. Results and Analysis.....</b>	<b>34</b>
4.1. Develop Value Hierarchy and Value Hierarchy Weights.....	34
4.2. Develop Evaluation Measures .....	40
4.3. Evaluation “Measures-by-Views” Matrix.....	43
4.4. Identifying Relationships and Numerical Descriptors.....	43
4.4.1. Non-Discriminating Evaluation Measures.....	46
4.4.2. <i>Architectural Quality</i> Evaluation Measures.....	47
4.4.3. <i>System Effectiveness</i> Evaluation Measures .....	48
4.4.3.1. OPERATIONAL NEEDS.....	50
4.4.3.2. THREAT DETECTION, THREAT ASSESSMENT, and WARNING PLAN ..	50
4.4.3.3. TECHNOLOGICAL AVAILABILITY, ADAPTATION, and SYSTEM REDUNDANCY .....	51
4.4.3.4. ENVIRONMENTAL IMPACT, NESI DEVELOPMENT, and NESI EVALUATION .....	51
4.4.3.5. MONETARY PRACTICALITY – INITIAL and MAINTENANCE.....	51
4.4.3.6. SUPPORTABILITY, RELIABILITY, and RECOVERABILITY REQUIREMENTS .....	52
4.4.3.7. JOINT OPERATIONS.....	52
4.5. Completed Matrix .....	53
4.5.1. View Analysis.....	56
4.5.2. Build Sequence Analysis .....	57
<b>Chapter 5. Conclusion.....</b>	<b>63</b>
5.1. Answers to Research Question .....	63
5.1.1. What DoDAF views are the most important to the JFPASS architecture? ..	64
5.1.2. What DoDAF views should be built based on the overall objective of the JFPASS architecture?.....	66
5.1.3. Which if any JCIDS required views are emphasized by the values associated with the JFPASS architecture?.....	67
5.1.4. Which if any views that are important to the JFPASS architecture are not required by JCIDS? .....	67
5.1.5. Based on the suggested network diagram from the DoDAF Deskbook (Department of Defense, 2003), in what order should the views be created to most rapidly increase the usefulness of the JFPASS Architecture? .....	68
5.3. Methodology Strengths.....	71
5.4. Methodology Weaknesses .....	71
5.5. Recommended Future Research .....	72
<b>Bibliography.....</b>	<b>74</b>

## List of Figures

<u>Figure</u>	<u>Page</u>
1. Suggested "Build Sequence" (Department of Defense, 2003) .....	14
2. The Enterprise Architecture Scorecard (Institute For Enterprise Architecture Developments, 2007).....	17
3. "Ends-by-Ways Matrix" for Army International Activities (RAND Arroyo Center, 2006).....	24
4. Comparison of Value Weights.....	39
5. Simplified Network Diagram for JFPASS Architecture.....	58
6. Cumulative Progress as a Function of Number of Completed Views .....	62
7. Growth Curve Comparison .....	69

## List of Tables

<u>Table</u>	<u>Page</u>
1. The DoDAF Views (Department of Defense, 2007) .....	12
2. Architecture Products by Uses (Department of Defense, 2007).....	13
3. Sample “Cause-and-Effect” Matrix .....	22
4. <i>System Effectiveness</i> Value Definitions .....	37
5. <i>Architecture Quality</i> Value Definitions .....	38
6. <i>Architecture Quality</i> Branch Measures .....	41
7. <i>System Effectiveness</i> Branch Measures .....	42
8. Initial Evaluation Measures by View Matrix .....	45
9. Non-Discriminating Evaluation Measures.....	46
10. <i>Architecture Quality</i> Evaluation Measures by View Matrix .....	48
11. <i>System Effectiveness</i> Evaluation Measures by View Matrix .....	49
12. Removal of Non-Discriminating Measures and Non-Associated Views .....	54
13. Completed Evaluation Measure by View Matrix .....	55
14. Rank Order of Most Important Views .....	57
15. Steepest Ascent Build Sequence.....	59
16. Most Successors Build Sequence.....	60
17. Most Critical Followers Heuristic.....	61
18. The Most Important Views for the JFPASS .....	64
19. Completed JFPASS Views (Mills, 2009) .....	70
20. Most Critical Successors Heuristic with JFPASS Current Status.....	70

# METHODOLOGY FOR VALUE-DRIVEN ENTERPRISE ARCHITECTURE

## DEVELOPMENT GOALS: APPLICATION TO DODAF FRAMEWORK

### **Chapter 1. Introduction**

The Department of Defense Architecture Framework (DoDAF) Version 1.5 is intended to be the guide for all architecture development in the Department of Defense (DoD) (Department of Defense, 2007). With a total of 29 views described in DoDAF, systems architects are presented with a dynamic tool kit from which to draw when making decisions about how to depict their system. Although the Joint Capabilities Integration and Development System (JCIDS) prescribes the use of 11 views in the system acquisition process, there is little guidance as to which views should be developed (Chairman of the Joint Chiefs of Staff, 2007). However, development of all 29 views is impractical and it is doubtful that such an effort would contribute significantly to system development. Therefore, some criteria are needed to decide which views provide the maximum value and justify the expenditure of time, effort, and money to produce. This thesis presents a methodology for making those types of decisions about DoDAF view creation.

#### **1.1. Background**

Force protection operations are currently disjointed and lack a common concept of operations (CONOPS) to integrate services, DoD agencies, and combatant commands

for the purpose of providing protection for U.S. forces from deployment origin through employment and redeployment (Protection Assessment Branch, Joint Staff, 2004). The lack of a common framework creates the potential for gaps in capabilities and an inability to put forth a united effort toward the common goal of force protection. Differing standards and procedures among services can also create gaps and hinder cooperation under the joint operations of a combatant commander. Furthermore, lack of consistency between strategies at deployment origin and employment location can cause vulnerabilities. Such a compartmentalized approach to force protection creates an environment that is likely to discourage sharing of critical information, which leads to low situational awareness and manpower intensive, reactionary responses to threats and attacks (Protection Assessment Branch, Joint Staff, 2004).

The Joint Vision 2020 (2000) outlines a strategic vision for joint operations including “full dimensional protection” (Chairman of the Joint Chiefs of Staff, 2000, p. 3). By conducting force protection operations in a joint environment and combining the core competencies of individual services, the combatant commander has more options and greater flexibility. In order to accomplish the strategic vision outlined by the Joint Vision 2020, the military needs to transition to a joint force, to include “intellectually, operationally, organizationally, doctrinally, and technically” (Chairman of the Joint Chiefs of Staff, 2000, p. 2).

The transition to joint force protection requires a common description that meets the needs of all services. The Joint Force Protection Advanced Security System (JFPASS) initiative seeks to describe a Joint Force Protection Concept of Operations (JFP CONOPS) using an enterprise architecture based on the DoDAF. The stakeholders in a

JFP CONOPS span four services and multiple functions within each service. The challenge of creating the JFPASS architecture requires senior decision-makers to balance the wide array of values and concerns that these stakeholders have. Value-Focused Thinking (VFT) is a decision analysis tool uniquely suited to helping decision-makers strike the appropriate balance between objectives and facilitates communication in a multiple stakeholder decision problem (Keeney, 1994).

Existing techniques for architecture evaluation are limited and focus mainly on single aspects of architecture such as interoperability (Ford, Colombi, Graham, & Jacques, 2007). For example, the Enterprise Architecture Scorecard provides a subjective guide for evaluating an architecture for completeness (Institute For Enterprise Architecture Developments, 2007). However, there does not appear to be any methodology for the evaluation of the importance of an architectural view to the overall architecture. Therefore, this research will seek to fill that gap by demonstrating a methodology for guiding the selection of views from the DoDAF to achieve the desired value from the resulting architecture. This will be accomplished by extending the Value-Driven Enterprise Architecture (VDEA) score, developed by Cotton and Haase (2009) and Mills (2009), to the planning and development of architecture.

## **1.2. Research Questions**

This research will link the individual views as described by the DoDAF to the value they can contribute to the objectives of the JFPASS architecture effort. By linking views to the lowest-level objectives of an objective hierarchy elicited using VFT, each view will be evaluated on its contribution to the overall objective. This research will answer the following questions:

1. What DoDAF views are the most important to the JFPASS architecture?
2. What DoDAF views should be built based on the overall objective of the JFPASS architecture?
3. Which if any JCIDS required views are emphasized by the values associated with the JFPASS architecture?
4. Which if any views that are important to the JFPASS architecture are not required by JCIDS?
5. Based on the suggested network diagram from the DoDAF Deskbook (Department of Defense, 2003), in what order should the views be created to most rapidly increase the usefulness of the JFPASS Architecture?

### **1.3. Methodology**

The VDEA methodology provides a means for developing a weighted value hierarchy to describe the values associated with an architecture and how those objectives contribute to the fundamental objective as collectively defined by the stakeholders. VDEA uses the value hierarchy to provide a means for evaluating a single architecture's progress toward meeting the fundamental objective. This research proposes an extension to VDEA to evaluate individual views and determine the contribution of views or set of views to achieving the fundamental objective.

The value hierarchy and associated measures will be used to create a “measures-by-views” matrix. Each cell in the matrix will represent the relationship between a particular view and a particular measure, by which the architecture is being scored. This process is similar to the creation of an “ends-by-ways” matrix (RAND Arroyo Center, 2006) or a “cause-and-effect” matrix (Tague, 2005). The “measures-by-views” matrix will identify the relationship between measures and views and numerically describe those relationships; when combined with the weighted value hierarchy, it will enable the

calculation of a score for single views and combinations of views. Using the ranked order of views and the suggested network diagram from the DoDAF deskbook (2003), a recommendation of which views to create and in which order can be generated.

#### **1.4. Assumptions and Limitations**

This research will seek to use global evaluation measure weights from a value hierarchy as a proxy to ascertain the importance of particular views to the completed architecture. In doing this, the value created by interdependencies between views was not considered; instead, the importance of each view was assumed to be linearly additive as determined by the evaluation measure weight. Additionally, multiple views can address a single measure but only one may be required. In the case where two or more views address a single measure, this research did not distinguish between them as to their efficacy in doing so.

Assuming sufficient quality architecture views, measures aimed at evaluating correctness or compliance with standards were not evaluated. It was also assumed that the system being described is the correct system for the purpose being considered. Combining these assumptions, any view added to the architecture can only improve the architecture by further describing the system.

This research sought to demonstrate a methodology for evaluating the DoDAF views; in doing so, a weighted value hierarchy was used that was specific to a Joint Force Protection Concept of Operations. Application of this methodology to other architecture efforts will require a value hierarchy that is applicable to that system. Creation of a value hierarchy can be a time consuming endeavor but if done correctly can provide benefits beyond the applications presented here. The value hierarchy can also be used for



evaluation of the architecture during development to measure progress as is presented by Cotton and Haase (2009); Mills (2009); Cotton, Haase, Havlicek, and Thal (2009); and Mills, Osgood, Thal, and Havlicek (2009).

### **1.5. Significance of Study**

This research demonstrates an extension of the VDEA score methodology to the evaluation of individual architecture views. The methodology presented here provides a means for evaluating individual DoDAF views and their contribution to the overall architecture. This extension is referred to as VDEA-Development Goals (VDEA-DG). This provides the program manager or other decision-makers with a convenient tool for resource allocation to the development of views. With additional information on the resources required for creating individual views, the tool could be expanded to identify an optimal set of views in a resource-constrained environment.

Beyond the system development program, this research provides insight into the JCIDS process and the views it requires. The static list of views required for JCIDS milestone approvals detracts from the creation of architecture for the purpose of improving an acquisition program. With a limited amount of resources to devote to architecture development, required views that add limited value to the program take resources away from the creation of views that are more important for the objectives of the architecture. The methodology presented in this research provides a means for justifying the expenditure of resources on the most important views.

Finally, this research will provide insight into the DoDAF and JCIDS and their consequences for value creation in architecture. An examination of the ways in which the DoDAF views contribute to the objectives of architecture provides a critique of the

entire DoDAF. Comparing the results of this research to JCIDS requirements for architecture can identify opportunities for increasing JCIDS support for creation of architecture to improve decision-making.

## **1.6. Overview of Remaining Chapters**

The remaining chapters introduce the concepts necessary for understanding this research, present the methodology used and the subsequent results, and draw conclusions and recommendations. Chapter 2 provides a review of joint force protection and system architecture, particularly the DoDAF. It also discusses the evaluation of architecture and VFT, as well as previous research pertinent to the current study. The methodology used to create a proxy for importance and develop a tool for evaluating architecture views is discussed in Chapter 3. Chapter 4 describes how the methodology was operationalized and presents the results and analysis. Finally, Chapter 5 interprets the results of the analysis, draws conclusions, and makes recommendations for further research.

## Chapter 2. Literature Review

This chapter introduces the concept of joint force protection and its importance to joint operations. It also provides an overview of enterprise architecture and the Department of Defense Architectural Framework (DoDAF) version 1.5 (2007) and how it is being applied to joint force protection. Existing literature on the evaluation of architecture is explored followed by a discussion of the Value-Focused Thinking (VFT) methodology and management tools for measuring performance. The chapter concludes with examples of research that measured value contribution of activities and resources towards a set of objectives.

### 2.1. Joint Force Protection

The flexibility and synergy of United States military joint operations is important when engaging an adaptive enemy. The ability to protect the joint force by countering asymmetrical threats aimed at degrading capabilities and the will to fight is necessary to be effective in warfare. This need for security in a joint operations environment is what necessitates the implementation of a joint force protection concept of operations (Chairman of the Joint Chiefs of Staff, 2004).

The Department of Defense's (DoD) doctrine on joint operations provides guidance to joint commanders in the implementation of joint operations and describes force protection as,

Force protection includes preventive measures taken to mitigate hostile actions against DoD personnel (to include family members), resources, facilities, and critical information. These actions conserve the force's fighting potential so it

can be applied at the decisive time and place and incorporates the integrated and synchronized offensive and defensive measures to enable the effective employment of the joint force while degrading opportunities for the adversary... Force protection is achieved through the tailored selection and application of multilayered active and passive measures, within the air, land, maritime, and space domains and the information environment across the range of military operations with an acceptable level of risk. (Chambal, 2001, pp. Ch 3 25-26)

This detailed definition shows the breadth and complexity of force protection in a joint environment.

The Protection Joint Functional Concept (Protection Assessment Branch, Joint Staff, 2004) describes a construct for conducting force protection operations that includes five functions: detect, assess, warn, defend, and recover. The basic process of this construct is to detect an attack either prior to or during its execution and then assess the available information in order to make a decision on how to respond to the attack. The decision on how to respond will result in warnings and or taskings to various units to take the appropriate defensive action to repel or mitigate the effects of the attack. Once the attack is over, it may be necessary to conduct recovery operations to restore military capability.

## **2.2. Fundamentals of Architecture and the DoDAF**

According to the Protection Joint Functional Concept, “current (force) protection efforts are characterized by channelized and sometimes conflicting efforts among the DoD agencies, combatant commands, and Services” (Protection Assessment Branch, Joint Staff, 2004). In order to achieve a unified and cooperative effort in the procurement of physical security equipment for the purpose of force protection, the Security Equipment Integration Working Group (SEIWG) is trying to establish a DoDAF-compliant architecture in the Joint Force Protection Advanced Security System (JFPASS)

initiative that describes joint force protection as a guide for acquisition efforts across the services.

The DoDAF encompasses 29 architectural products or “views” that can be used to describe a myriad of complex technical, physical, and conceptual systems (Department of Defense, 2007). The views are divided into four main categories: All Views (AV), Operational Views (OV), Systems and Services Views (SV), and Technical Views (TV). Each view is tailored to provide information on different aspects of the system with the different categories focusing on broad areas of the system. The two types of AVs provide general overview and background information as well as define the terms used in the architecture. The OVs describe the operational functions and structure of the system. The SVs detail the specific sub-system and components that make up the system and describes their interfaces and information exchanges. The two types of TVs focus on the current technical standards and how the technical standards are forecast to change over time (Department of Defense, 2007). Table 1 lists all of the DoDAF views and their titles.

A set of views describing a single system is called an architecture (Department of Defense, 2007). Architecture is a useful tool for the management of large organizations and in particular joint missions that are employing sophisticated systems and technology. It is also extensively used in systems engineering to describe technical systems under development. The use of architecture to describe joint force protection provides a structured and repeatable method for the analysis of investment alternatives for creating new physical security equipment and technology (Department of Defense, 2007).

The utility of systems architecture is so important to the DoD that the creation of architectural views is mandated by the Chairman of the Joint Chiefs of Staff. The Joint Capabilities Integration and Development System (JCIDS) prescribes a gated system development process that requires approval for movement from one phase of development to the next. At each transition point from one phase to the next, referred to as a milestone, specific DoDAF views are required to be submitted for review by a milestone decision authority (Chairman of the Joint Chiefs of Staff, 2007). DoDAF volume II (2007) provides further guidance on choosing additional views for development depending on the purpose of the architecture. There are 17 potential uses for architecture listed in the DoDAF, and views are suggested for each use of architecture to be considered for development (Department of Defense, 2007). However, with as many as 20 out of 22 views to consider for a particular use, this does not significantly narrow the area of consideration for the architect. Additionally, there may be many more uses for architecture than the 17 listed. Table 2 details the uses and views suggested for each. At this point, the DoDAF does not distinguish between views with the same number; for instance, there is no differentiation between the SV-4a and SV-4b.

**Table 1. The DoDAF Views (Department of Defense, 2007)**

<b>View</b>	<b>Title</b>
AV-1	Overview and Summary Information
AV-2	Integrated Dictionary
OV-1	High-Level Operational Concept Graphic
OV-2	Operational Node Connectivity Description
OV-3	Operational Information Exchange Matrix
OV-4	Organizational Relationships Chart
OV-5	Operational Activity Model
OV-6a	Operational Rules Model
OV-6b	Operational State Transition Description
OV-6c	Operational Event-Trace Description
OV-7	Logical Data Model
SV-1	Systems Interface Description Services Interface Description
SV-2	Systems Communications Description Services Communications Description
SV-3	Systems-Systems Matrix Services-Systems Matrix Services-Services Matrix
SV-4a	Systems Functionality Description
SV-4b	Services Functionality Description
SV-5a	Operational Activity to Systems Function Traceability Matrix
SV-5b	Operational Activity to Systems Traceability Matrix
SV-5c	Operational Activity to Services Traceability Matrix
SV-6	Systems Data Exchange Matrix Services Data Exchange Matrix
SV-7	Systems Performance Parameters Matrix Services Performance Parameters Matrix
SV-8	Systems Evolution Description Services Evolution Description
SV-9	Systems Technology Forecast Services Technology Forecast
SV-10a	Systems Rules Model Services Rules Model
SV-10b	Systems State Transition Description Services State Transition Description
SV-10c	Systems Event-Trace Description Services Event-Trace Description
SV-11	Physical Schema
TV-1	Technical Standards Profile
TV-2	Technical Standards Forecast

**Table 2. Architecture Products by Uses (Department of Defense, 2007)**

Uses of Architecture	All View		Operational View							System and Services View											Tech Stds View	
	1	2	1	2	3	4	5	6	7	1	2	3	4	5	6	7	8	9	10	11	1	2
Analysis & Assessment																						
Capabilities																						
Gaps/Shortfalls					x		x						x	x								
Mission Effects & Outcomes, Operational Task Performance	x	x	x	x	x	x		x		x	x				x	x				x	x	
Trade-Offs	x	x	x	x	x	x	x	x		x	x		x	x	x	x				x	x	x
Functional Solutions	x	x	x	x	x	x	x	x		x	x		x	x	x	x				x	x	x
Operations																						
Process Re-engineering	x	x		x	x		x	x														
Personnel & Organizational Design	x	x	x	x	x	x	x	x	x	x	x	x			x							
Doctrine Development/Validation	x	x	x	x	x		x	x														
Operational Planning (CONOPS and TTPs)	x	x	x	x	x	x	x	x		x	x	x	x	x								x
Systems/Services																						
Communications	x	x								x	x	x								x		x
Interoperability and Supportability	x	x	x	x	x	x	x	x	x	x	x		x		x	x	x				x	x
Evolution/Dependencies	x	x									x	x	x		x		x				x	x
Materiel Solutions Design & Development	x	x		x	x		x	x	x	x	x	x	x	x	x	x	x	x	x	x	x	x
Facilities Packaging	x	x		x			x	x		x	x		x	x								x
Performance							x	x						x		x				x		
Socialization/Awareness/Discovery																						
Training	x	x	x	x	x	x	x	x		x	x	x	x	x	x							
Leadership Development	x	x	x	x		x	x	x		x			x	x								
Metadata (for federation)	x	x																				x

Guidance on the build sequence of architectural views is provided in the DoDAF Version 1 Deskbook (2003). Although DoDAF version 1.5 does not include an updated deskbook, the version 1 deskbook still contains pertinent information for developers of architecture. The suggested “build sequence,” reproduced in Figure 1, is constructed to take advantage of the relationship between products and entities within products. The



“build sequence” takes advantage of information contained in multiple views to reduce the duplication of work. It also identifies steps to be taken along the way to a particular view to ensure completeness of that view. The process should be iterative, but building views in a logical sequence will help insure data integrity (Department of Defense, 2003).

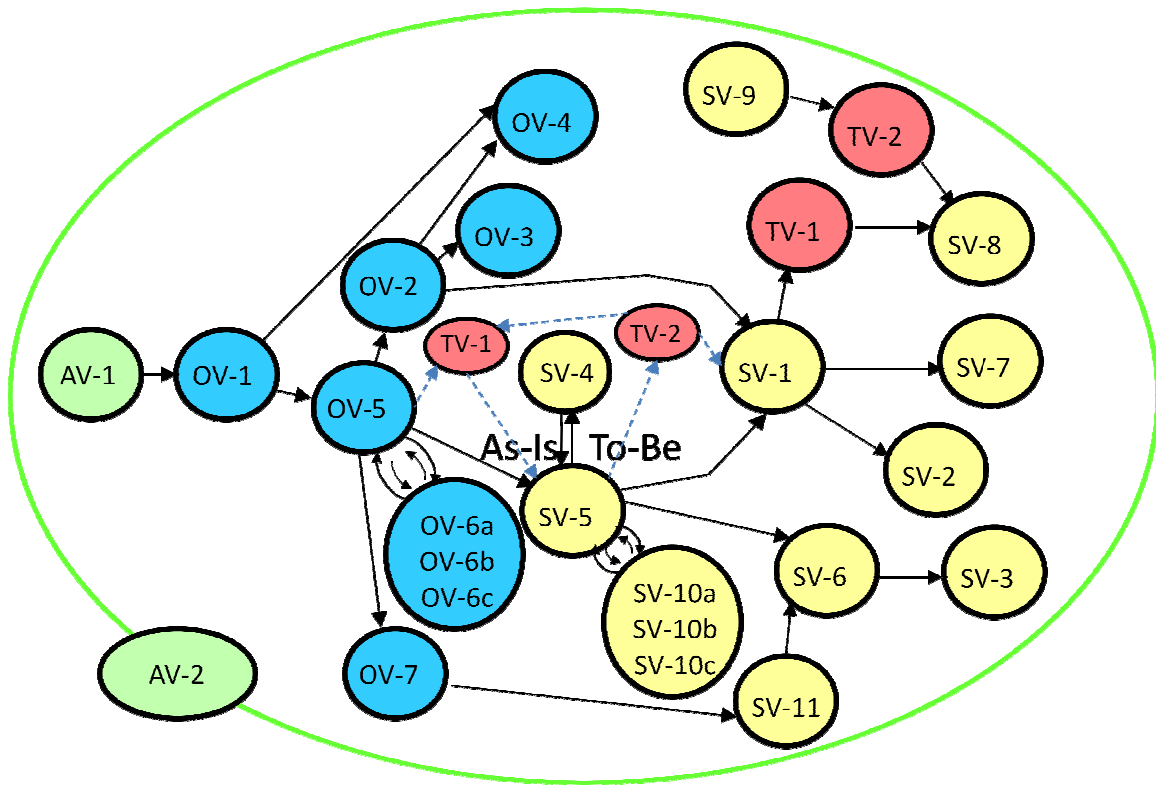

Figure 1. Suggested “Build Sequence” (Department of Defense, 2003)

The DoDAF suggested “build sequence” is not a sequence in the true sense of the word, since it does not present the views in a single order and there is not a single order suggested by the diagram. In effect the “build sequence” is an activity on node network diagram similar to that used in project management with each view representing an activity (Merideth & Mantel, 2006). As a result, several heuristic methods from the project management field can be used to solve for an actual build sequence based on a project’s constraints, such as the number of views that can be generated at a given time. The heuristics work by applying a given criteria to the selection of an activity to accomplish from the list of activities available. An activity is available when all of its prerequisites are complete. The heuristics apply criteria that range from selecting the activity with the shortest duration to selecting the activity that adds the most value to the project (Merideth & Mantel, 2006).

### **2.3. Evaluation of Architecture and DoDAF**

System engineering adds value to the system design process. Honour (2004) suggests that there is some correlation between the level of systems engineering effort and both the project development quality and the relative success of the project. Honour (2004) looks at the system engineering effort as a whole, to include system-architecting efforts, and uses only a qualitative evaluation of system engineering made by project participants. However, this subjective evaluation of systems engineering does not specifically address the quality of the architecture or the value it adds to the overall project.

A review of existing system architecture literature reveals that techniques and methodologies for specifically evaluating architecture are limited and mostly focus on a

single aspect or single type of system. For example, the i-Score methodology examines system interoperability by analyzing the interoperability of system pairs within a sequence of activities (Ford, Colombi, Graham, & Jacques, 2007). The score derived from this methodology represents the quality of a single aspect of architecture and does not indicate the overall quality or value of that architecture. The Architecture Tradeoff Analysis Method is designed for analyzing the tradeoffs in architecture decisions for software systems (Kazman, Klein, & Clements, 2000). The use of executable models and simulation can be used to test and validate the design of well developed systems, particularly in the areas of the system's process logic and software (Levis, Shin, & Bienvenu, 2000; Levis, Wagenhals, Shin, & Kim, 2000).

The Institute for Enterprise Architecture Development has created a scorecard establishing criteria to guide the review of enterprise architecture. The Enterprise Architecture Scorecard (2007) evaluates the enterprise areas of organization, information, information-systems, and technology-infrastructure at six levels of abstraction. These six levels of abstraction represent the six typical areas of concern for architecture: contextual, environmental, conceptual, logical, physical, and transformational. This evaluation provides 24 distinct areas for a reviewer to look at when evaluating an architecture as shown in Figure 2. The evaluation is based on a subjective assignment of a score to a series of broad questions (Institute For Enterprise Architecture Developments, 2007). This type of evaluation may give an indication as to whether the architecture was developed thoroughly enough as to sufficiently address all 24 areas being evaluated, but no link is made from the areas of evaluation to overall quality of the products or of their value to a design program.

	<b>Why?</b> Vision / Strategy Business / Technology Drivers Scope Contextual Level	<b>With Who?</b> Value Net Relations Cooperating / Collaborating Elements Environmental Level	<b>What?</b> Goals & Objectives Requirements Conceptual Level	<b>How?</b> Logical Representation Logical Level	<b>With what?</b> Solution Representation Physical Level	<b>When?</b> Enterprise Impact Transformational Level
Business						
Information						
Information – Systems						
Technology - Infrastructure						

**Areas of Evaluation**

**Figure 2. The Enterprise Architecture Scorecard (Institute For Enterprise Architecture Developments, 2007)**

#### 2.4. Value-Focused Thinking (VFT)

“Values are principles used for evaluation. We use them to evaluate the actual or potential consequences of action and inaction, of proposed alternatives, and of decisions” (Keeney, 1992, p. 6).

Value-Focused Thinking is a decision analysis tool that seeks to improve decision-making by quantifying the values of a decision-maker, generating alternatives based on those values, and comparing alternatives against those values. A decision by definition has multiple alternatives that will have differing consequences in terms of outcome and resource consumption (Kirkwood, 1997). Many times, decisions are made by focusing on obvious alternatives and selecting the best among them. This type of alternative-focused decision-making can be done quickly, but can inadvertently limit analysis to a small number of undesirable alternatives. One of the benefits of value-focused thinking is that it is unconstrained by alternatives and enables the decision-maker

to articulate an ideal consequence and then go about looking for or creating an alternative that best matches the ideal (Keeney, 1994).

#### **2.4.1. Benefits of Value-Focused Thinking**

The major difference between a typical decision-making process and value-focused thinking is a thorough value assessment. In many situations, the relevant values to a decision are known intuitively and a value assessment merely articulates those values. In other more complex decision problems, not all of the relevant values may be as obvious or other stakeholders may obscure values. A detailed value assessment can either discover or uncover these unknown or obscured values (Keeney, 1994). This is important since values represent the reason for interest in any decision problem and, as such, values can provide useful insights to all aspects of the decision-making process (Keeney, 1994).

For many decision situations, there are multiple stakeholders. For instance, each of the four service branches of the DoD represent a stakeholder in joint force protection, each with their own set of values and objectives. These differing value sets between stakeholders often lead to disagreement over the acceptability of various alternatives. If the discussion about the decision situation focuses solely on the identified alternatives, conflict will likely arise as the discussion turns into an argument over alternatives (Keeney, 1992). If the discussion is about the values of various stakeholders though, the underlying reason for disagreement can be uncovered; additionally, it is likely that the stakeholders share many of the same values. Understanding the similarities and differences in values between stakeholders can lead to new alternatives that better meet the objectives of all the stakeholders. Even just the effort of identifying the values of a

stakeholder and incorporating them into the decision process encourages stakeholder support for the decision (Keeney, 1992; Kirkwood, 1997).

The process of conducting a value assessment for strategic level values is also extremely beneficial as these values are stable over time and therefore can be reused to analyze new decision problems and guide efforts for achieving strategic objectives (Kirkwood, 1997; Keeney, 1992). The strategic values of joint force protection should not change in the near future and any changes that occur should be minor; therefore, the value hierarchy for joint force protection can be a long-term source of agreement among stakeholders.

#### **2.4.2. Previous Application of VFT in DoD**

The VFT methodology has been used in a variety of applications within the DoD. A brief review of these applications shows the versatility of VFT due to the universal applicability of values to decision problems. Knighton (1998) used VFT to explore the problem of course scheduling at the Air Force Institute of Technology. Using the Institute's objectives, instructor and student preferences, and facility constraints, an automated course-scheduling tool was created to solve a complex scheduling problem. This research incorporated the ability of VFT to balance objectives of multiple stakeholders with physical constraints to create the best alternative course schedule (Knighton, 1998).

Shoviak (2001) applied VFT to the selection of a solid waste management site for an Air Station in Alaska. In his research into this problem, Shoviak (2001) used the 10-step process for the application of VFT that was the basis for the VFT work done in this research. Jurk (2002) applied the same methodology to the selection of force protection

initiatives for further development. Keeter (2005) applied VFT to effects-based operations demonstrating the versatility of the process to be applied to multiple decision contexts including day-to-day operations.

## **2.5. Measuring Value**

An effectiveness measure seeks to provide information on the performance of a system or progress towards a desired end state (Bullock, 2006). Measuring performance is critical to the management of a process or organization. The simple fact that a particular metric is measured is often motivation enough for an organization to improve performance with regard to that metric. However, many organizations only measure financial metrics even though they profess the importance of performance in non-financial areas (Kaplan & Norton, 1996). This focus on financial indicators is criticized because it often encourages efforts to increase short-term financial results at the expense of long-term value creation (Porter, 1992). The challenge is how to measure the long-term creation of intangibles that often compete with the short-term financial rewards. For example, the intangibles of knowledge and expertise often compete with the financial benefits of outsourcing (Kaplan & Norton, 1996).

Several management tools are available to tackle the challenge of measuring performance with respect to a strategic vision or mission statement. For instance, the Balanced Scorecard approach as presented by Kaplan and Norton (1996) provides a “framework that translates a company’s vision and strategy into...performance measures.” The Balanced Scorecard approach focuses on performance from four perspectives: financial, customer, internal-business-process, and learning and growth. The idea is to link the objectives from a mission statement to the measures in each of the

perspectives to ensure a balanced approach to performance measurement (Kaplan & Norton, 1996). This is accomplished through a 10-step process that incorporates an organization's vision, mission, and strategy with input from senior executives to establish strategic objectives and identify measures for each objective (Kaplan & Norton, 1996). The Balanced Scorecard process of establishing objectives from strategic guidance and input of senior executives resembles the VFT process of eliciting an objective hierarchy from decision-makers. The advantages of VFT over balanced scorecard are the added steps of weighting objectives to guide the balancing of competing objectives and creating single dimensional value functions that facilitates the comparison between alternatives.

The "cause-and-effect" matrix is another management tool that analyzes how process steps contribute to customer requirements (Tague, 2005). Table 3 shows an example "cause-and-effect" matrix. The customer requirements, or "output variables," are weighted in terms of importance to the customer and listed across the top of the matrix. The process steps or "input variables" are listed down the side of the matrix. The influence of each input variable is rated against each output variable on a scale of 1 to 3, where 1 is little influence and 3 is highly influential; this is the first number in each input/output intersection of Table 3. The influence ratings of each input variable are then multiplied by the importance weight of the corresponding output variables; the resulting score is the second number in each input/output intersection of Table 3. This second number is summed for each input variable. The result is a score for each input variable that shows its relative influence on the output variables; this information can be used to allocate resources for improving the process being analyzed (Tague, 2005).



**Table 3. Sample “Cause-and-Effect” Matrix**

<b>Outputs</b>	<b>Output 1</b>		<b>Output 2</b>		<b>Output 3</b>		<b>Total</b>
<b>Weights</b>	1		4		2		
<b>Input 1</b>	Influence 3	Score 3	Influence 1	Score 4	Influence 3	Score 6	13
<b>Input 2</b>	Influence 1	Score 1	Influence 3	Score 12	Influence 2	Score 4	17
<b>Input 3</b>	Influence 2	Score 2	Influence 2	Score 8	Influence 2	Score 4	14

Research has also been done to specifically assess the value of an activity or resource in the context of achieving a set of objectives. The Research and Development (RAND) Corporation was contracted by the U.S. Army to assess the value of Army International Activities in accomplishing DoD objectives (RAND Arroyo Center, 2006). Additionally, Jones (2006) developed a methodology for military planners to assess the value of resources for accomplishing objectives in effects-based operations. The RAND Corporation and Jones research efforts are discussed in more detail below.

### **2.5.1. Assessing the Value of U.S. Army International Activities**

Since the Cold War, the DoD has developed a more flexible and comprehensive international cooperation strategy to deal with a more complex strategic environment. This has meant an increased profile and focus for the Army International Activities Program. Because of the increased focus, a need has arisen to assess the contribution of Army international activities to higher-level DoD objectives and improve decision-making on resource allocation. To fill this gap, the Army sponsored a research project by

the RAND Corporation to assess the value of U.S. Army International Activities (RAND Arroyo Center, 2006).

#### **2.5.1.1. Overview of research**

The major research problem the RAND Corporation wanted to address was to link Army international activities to the accomplishment of strategic level objectives and measure the extent to which individual activities contribute to achieving those objectives. In order to accomplish this, several issues needed to be addressed such as multiple stakeholders with various responsibilities, multiple objectives of different types and time horizons, and a diverse set of programs that made side-by-side comparisons difficult (RAND Arroyo Center, 2006).

The objectives for measuring the Army International Activities Program were derived in a multi-step process that began with the development of a set of objectives for security cooperation. Then a set of “ends” or lower-level objectives for the Army International Activities Program were established. Since this hierarchy of objectives was derived from government policy and directives such as the National Security Strategy, the Quadrennial Defense Review, and the Security Cooperation Guidance, it also reflects a reasonable set of objectives that any state might pursue through security cooperation (RAND Arroyo Center, 2006).

Next, the various Army international activities were grouped into categories or “ways” such as education and training, personnel exchanges, and exercises. Grouping the large and diverse number of activities into a smaller number of “ways” was done to make an assessment more manageable. The results of the objectives hierarchy with its lowest-level “ends” and the grouping of activities into “ways” is the “ends-by-ways”

matrix shown in Figure 3. This matrix was used to identify measures of effectiveness that evaluated the contribution of each “way” to each “end.” This process provided information on the magnitude of the contribution of each “way” to each “end” and how some “ways” can contribute to multiple “ends” (RAND Arroyo Center, 2006).

The Ways (from AIAP and TAP)	The Ends (from AIAP, TAP, DPG, QDR, and NSS)							
	Ensure Access	Promote Transformation	Improve Interoperability	Improve Defense Capabilities	Promote Stability and Democracy	Assure Allies	Improve Non-Military Cooperation	Establish Relations
Education and training								
Exercises								
Exchanges								
Military-to-military contacts								
International support								
Forums								
FMS + technical training								
RDT&E programs								

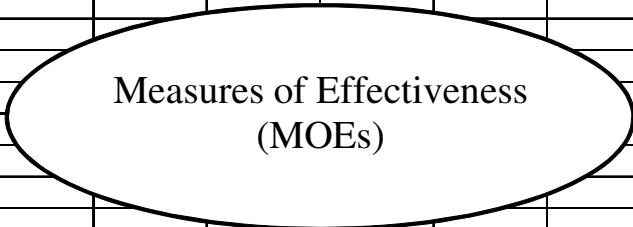

**Figure 3. "Ends-by-Ways Matrix" for Army International Activities (RAND Arroyo Center, 2006)**

### 2.5.1.2. Similarity to VFT

The RAND Corporation’s use of policy and strategy documents to ascertain a list of eight objectives for Army international activities mirrors the Gold Standard VFT methodology that relies on documentation of a decision-maker’s objectives or intent to create an objectives hierarchy (Burk & Parnell, 1997). The eight activity categories represent alternatives for achieving the eight objectives that can be scored individually or as a set of activities. One of the challenges of the RAND Corporation’s research (2006) was to establish causal linkages between activities and achieving objectives and from there developing Measures of Effectiveness that show how well different activities

accomplish objectives (RAND Arroyo Center, 2006). These Measures of Effectiveness equate to evaluation measures in the 10-step VFT process. The missing piece is the single dimensional value function that translates evaluation measures into a dimensionless value scale for comparison (Shoviak, 2001).

### **2.5.2. Resource Value in Effects-Based Operations**

The initial step of effects-based operations is to clearly define a desired end-state and “translate the desired end-state into fundamental campaign objectives” (Jones, 2006). It is the job of the military planners to utilize available resources to accomplish those objectives. Unfortunately, campaign objectives can compete for resources or directly conflict in terms of level of accomplishment; for example, the destruction of key enemy command and control nodes within a city may directly conflict with the desire to limit collateral damage. Jones (2006) presents a methodology for examining the value of resources in terms of accomplishing objectives and the interconnections between objectives for the purpose of aiding military planners in allocating resources.

The methodology presented by Jones (2006) assumes that national leadership and military commanders have provided an objectives hierarchy and that single actions can affect the achievement of multiple objectives both positively and negatively. This creates a situation similar to the RAND Corporation’s study (2006), in which each action represents an alternative that can be scored against a set of objectives either individually or as a set of actions. The degree to which an objective is met is converted to a dimensionless value scale ranging from zero to unity using a value function so that objectives can be compared on equivalent scales. In this manner, the progress of the

campaign can be measured in terms of its relative progress toward the desired end-state that would be represented by a perfect score for all objectives (Jones, 2006).

Additionally, the value of each resource can be measured in “the context of the degree of attainment of campaign objectives” (Jones, 2006). This can be done for a resource’s value in attaining a single objective but is more useful in the context of all stated objectives as some objectives may be conflicting. Evaluating resources against all objectives requires a weighted value hierarchy from which a multiple objective value function can be generated to calculate a resource’s contribution to the overall campaign objective (Jones, 2006).

### Chapter 3. Methodology

As discussed in Chapter 1, the Department of Defense Architectural Framework (DoDAF) describes 29 standardized architectural views for use in describing complex systems. A primary reason for creating an architecture is to support decision-making and communication in the Department of Defense (DoD) (Department of Defense, 2007). The development of particular architecture views is required for milestone decision points under the Joint Capabilities Integration and Development System (JCIDS) process (Chairman of the Joint Chiefs of Staff, 2007). However, development of each view is both time and resource intensive; requiring input from subject matter experts and system engineers with specialized training. The creation of all 29 views is not practical and likely not optimal to system development. Some guidance exists to help the architect select views, but this is limited and provides only a narrowed field of views from which to select (Department of Defense, 2007).

The methodology presented here is an extension of the Value-Driven Enterprise Architecture (VDEA) score and is complemented by the work of Cotton and Haase (2009) and Mills (2009) in the application of Value-Focused Thinking (VFT) to architectural analysis. The purpose of this methodology is to provide the manager of an architectural design effort a tool for view selection as well as provide insight into the importance of individual views and groupings of views. The application of the methodology presented here is specific to the problem of Joint Force Protection but the methodology is applicable to other problems as an add-on to VDEA. Further application

of this methodology may provide further insight into the value of individual and groupings of views as they apply to different types of problems.

### **3.1. Data Collection**

Data collection for this research followed the initial steps of the 10-step VFT methodology first developed by Chambal (2001). This methodology was selected because of its simplicity, which aids in communication with the decision-maker. The extensive application of the 10-step VFT methodology in the DoD includes utility privatization (Braziel, 2004), selection of force protection initiatives (Jurk, 2002), and strategic airlift (Tharaldson, 2006). The multiple successful applications of the 10-step process provide validity to the tool and its extension to a Joint Force Protection Advanced Security System (JFPASS) Architecture. This application of the 10-step process was iterative with frequent feedback loops to previous steps to make changes and revalidate results.

The first step of the 10-step process was to identify the problem. It was important to ensure that the problem and its scope was understood by all parties to the decision as this defined the boundary of the JFPASS architecture decision context and greatly influenced the resulting value hierarchy. The second step was to develop the value hierarchy that was applicable to the decision context and in accordance with the values of the Security Equipment Integration Working Group (SEIWG) chairman and subject matter experts in force protection and architecture (Chambal, 2001). The values at the lowest level of the value hierarchy are referred to as the last or lowest-tier values.

In step 3 for each lowest-tier value, an evaluation measure was developed. Evaluation measures were either direct measures or proxy measures. A direct evaluation

measure was preferred as it directly measures the attainment of a value; however, in some instances this is not practical or possible (Chambal, 2001). For instance, the national economic health is difficult to measure directly; therefore, the Gross Domestic Product is used as a proxy in most cases. Evaluation measures also have either natural or constructed scales. A natural scale is one that is commonly used for that type of measurement; for instance, the speed of an automobile is typically measured in miles per hour. In many cases, a natural scale was not available and a scale needed to be constructed for this research. A constructed scale would be the construction quality of an automobile rated as low, medium, or high. In general, a natural scale is preferred over a constructed one as a natural scale is already widely used and understood (Chambal, 2001).

Once the evaluation measures were determined, step 4 was to create a single dimensional value function for each measure. A single dimensional value function transposes an evaluation measure from the scale in which it is measured to a dimensionless scale of value ranging from zero to unity. The use of a common value scale for all evaluation measures allows for the summation of the measures to obtain a total score (Chambal, 2001).

The last step to complete the hierarchy, step 5, was to determine the relative weights for the objectives at each level. The weighting of objectives accounts for the extent to which lower-level objectives contribute to higher-level objectives and the relative importance of objectives to the decision-maker (Chambal, 2001). For the purposes of this research, the completed objectives hierarchy, and specifically the global measure weights, is all that is required from this process. This research uses the



weighting as a proxy for importance to evaluate architecture views and answer the research questions from Chapter 1.

### **3.2. Ways to Means Analysis**

At this point, this thesis diverts from the 10-step VFT to tools similar to those used by the RAND Corporation (RAND Arroyo Center, 2006) and Jones (2006); it resembles the “cause-and-effect” matrix and associated methodology described by Tague (2005). However, this application differs in several significant ways. The effects or ends being examined are the objectives of joint force protection architecture as elicited from multiple stakeholders using the VFT process. The resources, causes, or ways being examined are the 29 architectural views described by the Department of Defense Architecture Framework (DoDAF). The process used in this research is detailed below.

#### **3.2.1. Create Matrix and Identify Relationships**

The first step is to create a matrix with the evaluation measures from the hierarchy on one side and the DoDAF views across the top. This matrix is the basis for all further analysis. The second step is to identify the views that can contribute to, or fulfill on their own, a given evaluation measure. At this point, it is assumed that any view if done correctly will not detract from any evaluation measure; it is also assumed that any view that is created will be done so to a satisfactory standard. Some evaluation measures will be related to every view; these are the evaluation measures that relate to the quality of the created views. These measures should be noted as such, as they are non-discriminating between views and can be left out of the analysis since they offer no insight into the importance of an individual view.

### 3.2.2. Describe Relationships

The third step is to describe the strength of relationship between each evaluation measure and each view. The strength of relationship will be described on a scale from zero to one, with zero representing no relationship and one representing an exclusive relationship between a particular view and a particular measure. When more than one view is associated with a measure, the strength of the relationship of the measure to each associated view will be assumed to be one over the number of views associated with that measure. In other words, all views associated with a measure are assumed to contribute equally to that measure. In the case that a view does not contribute to a particular measure, the field in the matrix is left blank and takes the value of zero for calculations.

### 3.3. Analysis

The analysis was done in two parts to answer the four research questions from Chapter 1. First, each view was looked at individually to determine its importance as a single view and which views are most important to the JFPASS architecture. Second, the views were rank-ordered by importance and a build sequence was generated using the DoDAF recommended network diagram.

#### 3.3.1. View Analysis

The first part of the analysis is the simplest since it considers only one view at a time. The numerical relationship descriptions for each view are multiplied by the corresponding measure weight and the products are summed across all the evaluation measures. This summation results in a dimensionless score for each view that can be compared against the score for other views. The equation used for this calculation is:

$$I(x) = \sum_{i=1}^n w_i l_i(x_i) \quad (1)$$

where  $I(x)$  is the overall importance score of the view,  $w_i(x_i)$  is the importance of the view on the  $i^{th}$  measure,  $\lambda_i$  is the weight of the  $i^{th}$  measure,  $n$  is the total number of measures, and  $x_i$  is the strength of the relationship between view and the  $i^{th}$  measure.

Listing the views by score identifies the most important and the least important views. This answers the first research question from Chapter 1. Comparing the sorted list of views to the Joint Capabilities Integration and Development System (JCIDS) required views identifies the views that are not required but considered to be of importance, and the views that are required but considered to be of minimal importance. This is the answer to research questions 3 and 4 from Chapter 1. The second phase of the analysis will consider all of the views that are important to the architecture. The objective is to find a collection of views that can meet all the evaluation measures.

### **3.3.2. Build Sequence**

The recommended build sequence for the quickest increase in utility is generated using the network diagram from the DoDAF Deskbook (2003). The network diagram that DoDAF suggests shows prerequisites for each view similar to the network diagram method that is frequently used in project management (Merideth & Mantel, 2006). The network diagram is simplified to include only the views that are found to be important or are prerequisites for a view that is found to be important. Starting with no views having been built, the network diagram is used in conjunction with three heuristics from the precedence diagramming method. The first heuristic is based on the order of importance and always selects the most important view from those available at a given point in the network. The objective of this heuristic is to achieve the “steepest ascent” possible in the growth curve of the project at a given decision point. The second heuristic is the “most

successors” heuristic, which selects the view with the most successors from those that are available. The last heuristic is similar to the second but only considers critical successors and is known as the “most critical followers” heuristic (Merideth & Mantel, 2006). For this application, not all views found to be important will be considered critical; only the top few most important will be used, with the exact delineation being subjective.

### **3.4. Limitations**

The application of this methodology requires a value hierarchy tailored to the exact architecture project being evaluated. As such, this research is only intended as a demonstration of the methodology. Further, full validation will require additional applications to a variety of architecture projects. With additional applications, trends may also be identified that may have wider implications on architectural development. Views that are repeatedly found to be important to architecture projects should be included in policy as requirements for milestone decisions. Views that are repeatedly found not to be important to architecture projects should be reviewed to analyze their continued value.

## Chapter 4. Results and Analysis

This chapter covers the results of data collection and the analysis of those results. The collection of data was based on the application of the first five steps of the 10-step Value-Focused Thinking (VFT) methodology to the development of a Value-Drive Enterprise Architecture (VDEA) score to evaluate a Joint Force Protection Advanced Security System architecture. The VFT process was accomplished iteratively with numerous updates and revalidation of previous steps. This yielded a weighted objectives hierarchy and evaluation measures. This chapter also describes the creation of an evaluation “measures-by-views” matrix and how that matrix was evaluated to determine the importance of individual architecture views and develop recommendations for view development.

### 4.1. Develop Value Hierarchy and Value Hierarchy Weights

The development of a value hierarchy involved literature review, affinity diagramming, and validation by Security Equipment Integration Working Group (SEIWG) members and experts in force protection. A review of pertinent architecture evaluation literature and force protection literature provided a frame of reference to work from as well as a list of “ilities” associated with architecture and force protection for an affinity diagramming exercise. The affinity diagramming exercise considered over a hundred concepts and used group consensus to arrange them in categories based on their similarity and associations with one another. First, concept terms were placed in groups based on their similarity in meaning, then these groups were clustered based on similarity

of the overarching concept they were addressing. From this exercise, a draft value hierarchy was developed. This draft hierarchy was then presented to the SEIWG chairman and a wide variety of subject matter experts to obtain feedback and validation. Some minor adjustments to the hierarchy were made based on the feedback. A finalized value hierarchy was validated by the SEIWG chairman and subject matter experts.

With the structure of the value hierarchy complete, the relative weighting was done with the SEIWG chairman and a group of subject matter experts in both architecture and force protection. The weighting was accomplished by proceeding from the top of the hierarchy in a branch-by-tier fashion and assigning local weights to objectives relative to the other objectives in a given tier of a given branch. Adjustments to the hierarchy were made and global weights were calculated in real time to show participants how the changes being made affected the hierarchy as a whole.

The resulting hierarchy has two main branches representing the quality of the architecture and the effectiveness of the system being described by the architecture, with the effectiveness of the system accounting for 60% of the architecture's value. The *System Effectiveness* branch is broken into the *capability*, *maintainability*, and *interoperability* of the system. *Capability* is the most important system effectiveness value accounting for 45% of the value in that branch, with *Maintainability* and *Interoperability* splitting the remaining 55%. The *Architecture Quality* branch is broken into four branches representing *Accessibility*, *Usability*, *Modifiability*, and *Accountability*. Of these four values, *Usability* is the most valued, *Accessibility* and *Accountability* are equally valued, and *Modifiability* is the least valued of the four. The definitions of all the *System Effectiveness* values can be found in Table 4, while the definitions of the

*Architecture Quality* branch can be found in Table 5. These tables are structured to demonstrate the organization of the hierarchy. For a more detailed account of *Architecture Quality* values see Cotton and Haase (2009). For details on *System Effectiveness* values see Mills (2009).

A comparison of the weights of each of the lowest-tier values shows that *Purposefulness* is the most important value trailed by *Communication*. The *System Effectiveness* values are weighted more heavily due to the 60/40 split in favor of *System Effectiveness* at the top level of the hierarchy. Figure 4 shows a graphical comparison of the lowest level weightings. The values of *Dependability*, *Understandability*, and *Resiliency* are on the same tier as the other lowest-tier values but each is further decomposed. The values under these three values are stacked in the graphical presentation to allow comparison across a single level of decomposition.

**Table 4. System Effectiveness Value Definitions**

<b>System Effectiveness Values</b>	<b>Value Definition</b>
<b>Capability</b>	A system's ability to produce the expected or desired results on the battlefield.
<b>Purposefulness</b>	The ability of a system to address the problem which it is intended to solve. The relevance of a system in a given context or
<b>Practicality</b>	The system's ability to be achieved within realistic constraints, including economic, constructability, and timeliness.
<b>Flexibility</b>	The ability of a system to be changed based on Operational need. This changeability refers to its ability to be altered before, during and after a conflict.
<b>Maintainability</b>	A system's ability to be kept at its intended level of operation.
<b>Dependability</b>	A system's ability to continue operating at its intended standard.
<b>Supportability</b>	The ability of a system to be realistically sustained and remain functional and useful given the expenditure of a reasonable amount
<b>Reliability</b>	The ability of a system to perform as intended and execute given functions if properly maintained and supported.
<b>Resiliency</b>	A system's ability to be returned to its intended standard.
<b>Survivability</b>	The ability to survive attack or other enemy action and continue to operate as originally intended or retain the ability of being repaired and restored to operational status.
<b>Recoverability</b>	The system's ability to be repaired or recovered following an attack or other damage within an allotted time frame.
<b>Interoperability</b>	A system's ability to be applied within different contexts, including other services and organizations.
<b>Interchangeability</b>	The ability of parts, components, systems, units, and people to be substituted across organizations and systems within the system of systems.
<b>Communication</b>	The system's ability to transmit information in timely and accurate way as to facilitate analysis, decision making, and decisive



**Table 5. Architecture Quality Value Definitions**

<i>Architecture Quality Values</i>	<i>Value Definition</i>
<i>Accessibility</i>	The assurance that information relating to architecture products can only be accessed or modified by those authorized to do so, preventing information use outside the intended context.
<i>Subscribability</i>	How easily the information pertinent to a stakeholder can be accessed.
<i>Controllability</i>	The assurance that only those authorized to modify architecture information can do so with appropriate revision control measures.
<i>Protectability</i>	The assurance that only those authorized to access the information may do so.
<i>Usability</i>	The extent to which the architecture framework can be used by users to achieve goals effectively and efficiently.
<i>Longevity</i>	The degree to which the architecture product is available over time (i.e.: documentation).
<i>Understandability</i>	The level of difficulty needed to understand what the architecture is conveying.
<i>Simplicity</i>	How many diverse and autonomous but interrelated and interdependent components or parts are linked through many
<i>Readability</i>	How easy the information is conveyed to the reader.
<i>Modifiability</i>	How easy the architecture framework can be updated, upgraded, or otherwise accepts changes.
<i>Scalability</i>	The ability of the architecture to maintain its function and retain its desired properties when its scale is increased greatly without having a corresponding increase in complexity.
<i>Evolvability</i>	The ability of the architecture to change as needed to handle refinements.
<i>Tailorability</i>	The ability of the architecture products' level of detail to be changed to meet the needs of different stakeholders.
<i>Accountability</i>	The ability of the architecture to be responsible for addressing the stakeholders requirements.
<i>Compliance</i>	How effective architecture products comply with DoDAF standards.
<i>Traceability</i>	The extent to which the information in the Operational Views match the information in the System Views.
<i>Consistency</i>	The agreement of parts or features of architecture products to one another or a whole.
<i>SME Input</i>	The extent of pertinent Subject Matter Expert involvement in architecture development.

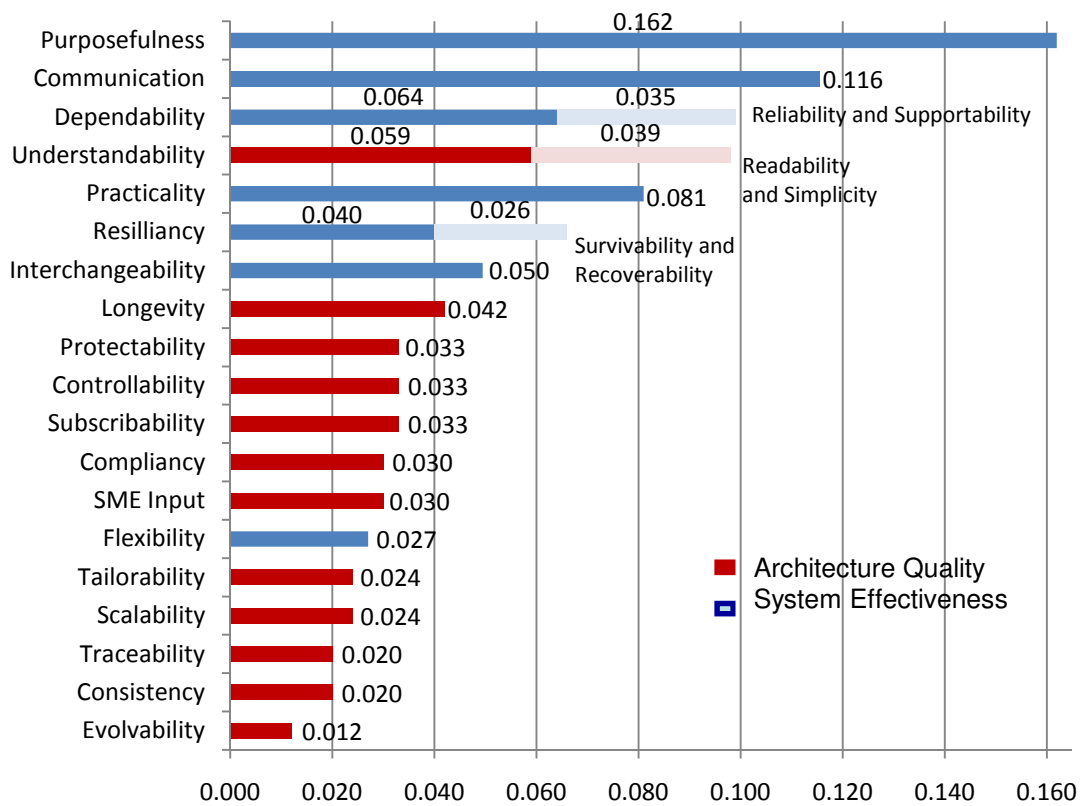

Figure 4. Comparison of Value Weights

## 4.2. Develop Evaluation Measures

Once the values of the value hierarchy were established, each of the lowest-level values needed at least one measure. The research team developed a draft set of measures and presented it to the same set of subject matter experts and SEIWG members as the value hierarchy. These measures took on two basic forms; they either looked for aspects of the architecture that added value or they looked to identify aspects of the architecture that detracted from its value. An aspect that would add value might be the inclusion of critical force protection concepts such as a threat assessment plan. An aspect that would detract value might be the presence of unnecessary or duplicative information.

Discussion on the draft measures resulted in numerous modifications as well as the deletion and addition of measures. The discussion also included the information that would be needed to score the measures as well as the views within which the information would be contained; the views that the group identified were recorded as part of the measure. Once the measures were complete, the weighting of the completed value hierarchy was revalidated. The complete list of measures, including their definitions and locations to find the information to score them, can be found in Table 6 and 7 for the *Architectural Quality* and *System Effectiveness* branches, respectively.

**Table 6. Architecture Quality Branch Measures**

Architecture Quality Branch				
Value	MEASURES	Measure Definition	Location	Measure Weight
<i>Subscribability</i>	Access	Do stakeholders have easy electronic access to products?	AV-1	0.022
<i>Subscribability</i>	Product Locatability	Can Stakeholders easily locate electronic products?	AV-1	0.011
<i>Controllability</i>	Document Protection	Are the products appropriately write-protected?	AV-1	0.033
<i>Protectability</i>	Access Control	Are access control measures implemented appropriately to the level of protection required?	AV-1	0.033
<i>Longevity</i>	File Management	Has an official file management system for keeping products been established?	AV-1	0.021
<i>Longevity</i>	File Format	To What degree is there a reasonable expectation that the electronic products will be viewable in the future?	AV-1	0.021
<i>Simplicity</i>	Connections	What percentage of products contain links between entities that are easy to understand?	All Views	0.013
<i>Simplicity</i>	Architecture Redundancy	What is the ratio of unnecessary duplication to items of information?	All Views	0.013
<i>Simplicity</i>	Architecture Economy	Are multiple steps unnecessarily being used to represent the same activity?	All Views	0.013
<i>Readability</i>	OV Readability	Percentage of Operational Views presented clearly and concisely?	All OVs	0.029
<i>Readability</i>	SV Readability	Percentage of System View information presented clearly and concisely?	All SVs	0.029
<i>Scalability</i>	Scale	Can architecture scale be increased while retaining its desired function and properties without increasing complexity?	All Views	0.024
<i>Evolvability</i>	Tool Format	To what degree are products developed with a tool that enforces DoDAF view consistency and allows for easy editing?	AV-1, or All Views	0.012
<i>Tailorability</i>	Decomposition	How many levels of decomposition are present?	OV-5	0.024
<i>Compliance</i>	DoDAF Compliance	What percentage of architecture products comply with DoDAF standards?	All Views	0.030
<i>Traceability</i>	Requirement Traceability	Does the SV-5 clearly account for all activities in the OVs?	SV-5	0.020
<i>Consistency</i>	Internal Consistency	What percentage of available architecture products have no internal inconsistencies?	All Views	0.010
<i>Consistency</i>	External Consistency	What percentage of available architecture products have no external inconsistencies?	All Views	0.010
<i>SME Input</i>	SME Effectiveness	How effective are SME's in architecture development?	AV-1	0.015
<i>SME Input</i>	SME Involvement	How many SMEs are involved with architecture development?	AV-1	0.015

**Table 7. System Effectiveness Branch Measures**

System Effectiveness Branch				
Value	MEASURES	Measure Definition	Location	Measure Weight
<i>Purposefulness</i>	Operational Needs	What percentage of operational needs are addressed by the system? Do the functions all relate back to operational needs?	AV-1, OV-1, OV-3, OV-5, SV-5, SV-7	0.041
<i>Purposefulness</i>	Threat Detection	Has a Threat Detection Plan been established?	OV-1, OV-3, OV-5	0.041
<i>Purposefulness</i>	Threat Assessment	Has a Threat Assessment Plan been established?	OV-1, OV-3, OV-5	0.041
<i>Purposefulness</i>	Warning Plan	Has a base warning plan been established?	OV-1, OV-3, OV-5	0.041
<i>Practicality</i>	Technological	What is the Technological Availability of the system?	SV-9	0.020
<i>Practicality</i>	Environmental Impact	Can the system be realized within Environmental Constraints?	TV-1	0.020
<i>Practicality</i>	Monetary Practicality - Initial	Can the system's initial cost be realized within current budgetary constraints?	OV-5	0.020
<i>Practicality</i>	Monetary Practicality - Maintenance	Can the system be maintained within current budgetary constraints?	OV-5	0.020
<i>Flexibility</i>	Adaptation	How well does the system adapt to changing threats?	SV-8	0.027
<i>Supportability</i>	Supportability Requirements	Have supportability requirements been accounted for?	SV-7	0.035
<i>Reliability</i>	Reliability Requirements	Have reliability requirements been accounted for?	SV-7	0.064
<i>Survivability</i>	System Redundancy	The degree to which critical systems are redundant?	OV-6	0.040
<i>Recoverability</i>	Recoverability Requirements	Have recoverability requirements been accounted for?	SV-7	0.026
<i>Interchangeability</i>	Joint Operations	Have CONOPs been constructed to account for all organizations?	AV-1, OV-2, OV-3, OV-4, SV-2	0.033
<i>Communication</i>	NESI Development	Was NESI Guidance taken into account when constructing architecture?	TV-1	0.066
<i>Communication</i>	NESI Evaluation	Has a NESI evaluation been completed on the architecture?	TV-1	0.066

Using the resulting Value-Driven Enterprise Architecture (VDEA) score on the Joint Force Protection Advanced Security System (JFPASS) architecture provided a baseline from which improvements to the architecture could be judged. During the analysis of the architecture, it was noted that some of the measures scored poorly because the views that contain the information needed to assess the measure had not yet been developed (Cotton & Haase, 2009; Mills, 2009). The absence of these views detracted from the overall value score for the architecture, which shows that some views are particularly valuable to the decision-maker. For more information on the application and analysis of the VDEA score to JFPASS and the Information and Resource Support System, refer to Cotton and Haase (2009) and Mills (2009).

#### **4.3. Evaluation “Measures-by-Views” Matrix**

The VDEA methodology identified 36 evaluation measures from the value hierarchy for JFPASS architecture. Combining those 36 evaluation measures with the 29 possible views from the Department of Defense Architectural Framework (DoDAF) creates a matrix with 1,044 relationships between views and evaluation measures. After initial identification of relationships between measures and views, this matrix can be reduced by removing non-discriminating measures and views that are not related to the remaining measures. This results in the removal of nine measures leaving a total of 27 measures that are used in this evaluation.

#### **4.4. Identifying Relationships and Numerical Descriptors**

The process of identifying relationships was based on the findings from the VDEA process, which identified for each measure the required views that would provide the information needed to score the architecture. The view identification was done as

part of the development of the evaluation measures step of the VDEA process. Many of the evaluation measures and the view relationships were validated during the scoring of the JFPASS architecture with the VDEA process, though some of the views required for evaluation were not available so those relationships were not validated (Cotton & Haase, 2009; Mills, 2009). A review of the DoDAF requirements for views was used to help validate all the identified relationships. The initial identification of relationships can be seen in Table 8. The numerical descriptors of the strength of the relationships were assumed linearly additive across each measure. That is the strength of the relationship between a view and a measure is one over the total number of views associated with the measure.

$$x_i = \frac{1}{M_i} \quad (2)$$

where  $x_i$  is the strength of the relationship between view and the  $i^{th}$  measure and  $M_i$  is the number of views associated with the  $i^{th}$  measure.

**Table 8. Initial Evaluation Measures by View Matrix**

Values	MEASURES	AV-1	AV-2	OV-1	OV-2	OV-3	OV-4	OV-5	OV-6a	OV-6b	OV-6c	OV-7	SV-1	SV-2	SV-3	SV-4a	SV-4b	SV-5a	SV-5b	SV-5c	SV-6	SV-7	SV-8	SV-9	SV-10a	SV-10b	SV-11	SV-12	
Subscribability	Access	x																											
Subscribability	Product Locatability	x																											
Controllability	Document Protection	x																											
Protectability	Access Control	x																											
Longevity	File Management	x																											
Longevity	File Format	x																											
Simplicity	Connections	x																											
Simplicity	Architecture Redundancy	x																											
Simplicity	Architecture Economy	x																											
Readability	OV Readability	x																											
Readability	SV Readability	x																											
Scalability	Scale	x																											
Evolvability	Tool Format	x																											
Tailorability	Decomposition	x																											
Compliance	DoDAF Compliance	x																											
Traceability	Requirement Traceability	x																											
Consistency	Internal Consistency	x																											
Consistency	External Consistency	x																											
SME Input	SME Effectiveness	x																											
SME Input	SME Involvement	x																											
Purposefulness	Operational Needs	x																											
Purposefulness	Threat Detection	x																											
Purposefulness	Threat Assessment	x																											
Purposefulness	Warning Plan	x																											
Practicality	Technological Availability	x																											
Practicality	Environmental Impact	x																											
Practicality	Monetary Practicality - Initial	x																											
Practicality	Monetary Practicality - Maintenance	x																											
Flexibility	Adaptation	x																											
Supportability	Supportability Requirements	x																											
Reliability	Reliability Requirements	x																											
Survivability	System Redundancy	x																											
Recoverability	Recoverability Requirements	x																											
Interchangeability	Joint Operations	x																											
Communication	NESSI Development	x																											
Communication	NESSI Evaluation	x																											



#### 4.4.1. Non-Discriminating Evaluation Measures

Several of the evaluation measures concern the quality of the existing views and are not associated with any particular view. These non-discriminating measures are listed in Table 9. These measures differ from the other measures because instead of looking for the architecture to convey some specific information, they seek to measure the quality of existing views; therefore, any set of views can be evaluated against these measures. This means that no view is more important to these measures than any other view. For example, if the only view created was the OV-1, then when it is evaluated for the measure connections this view could gain all available value for that measure. Likewise, if the OV-5 is the only view created, then it too would gain full value under that measure. Since these non-discriminating measures are equally applicable to all views, they are not useful in discriminating between views. For this reason, they are not included in the analysis.

**Table 9. Non-Discriminating Evaluation Measures**

MEASURE	Applicability
Connections	Measures All Available Views
Architecture Redundancy	Measures All Available Views
Architecture Economy	Measures All Available Views
OV Readability	Measures All Available Operational Views
SV Readability	Measures All Available System Views
Scale	Measures All Available Views
DoDAF Compliancy	Measures All Available Views
Internal Consistency	Measures All Available Views
External Consistency	Measures All Available Views

#### 4.4.2. *Architectural Quality Evaluation Measures*

The non-discriminatory measures are all part of the architectural quality branch of the value hierarchy. With their removal, there are 11 *Architectural Quality Evaluation Measures* remaining; these are summarized with their architecture view relationships in Table 10. The majority of these measures are identified as being related to the AV-1. The DoDAF volume II (2007) describes the AV-1 as both an “executive level summary” and a “planning guide” for architecture development; as a result, it makes sense that most of the information needed to determine the value of an architecture would be contained there. For instance, the involvement of subject matter experts (SME) was determined to contribute to the value of an architecture and is represented in the value hierarchy by the value *Stakeholder Involvement*. *Stakeholder Involvement* has two evaluation measures, SME EFFECTIVENESS and SME INVOLVEMENT; in order to measure it, information on the number of SMEs, their branch of service, and years of experience are needed. All of this information can be included in an AV-1 under the heading of Architecture Project Identification.

**Table 10. Architecture Quality Evaluation Measures by View Matrix**

MEASURE	Source Views												
	AV-1	OV-1	OV-2	OV-3	OV-4	OV-5	OV-6	SV-2	SV-5	SV-7	SV-8	SV-9	TV-1
Access	X												
Product Locatability	X												
Document Protection	X												
Access Control	X												
File Management	X												
File Format	X												
Tool Format	X												
Decomposition						X							
Requirement Traceability									X				
SME Effectiveness	X												
SME Involvement	X												

The evaluation measures of DECOMPOSITION and REQUIREMENT TRACEABILITY are related to the OV-5 and SV-5, respectively. DECOMPOSITION specifically measures the level of decomposition in the OV-5. REQUIREMENT TRACEABILITY is measured as a percentage of requirements that are traced to functions in an SV-5. The DoDAF describes three types of SV-5, designated as the SV-5a (Operational Activity to System Functions Traceability Matrix), the SV-5b (Operational Activity-to-Systems Traceability Matrix), and the SV-5c (Operational Activity to Services Traceability Matrix). For the purposes of measuring TRACEABILITY, all three versions of the SV-5 are capable of displaying the necessary information so they are considered equivalent and referred to collectively as SV-5.

#### 4.4.3. System Effectiveness Evaluation Measures

The remaining 16 Evaluation Measures fall under the *System Effectiveness* branch and were found to be related to a total of 13 views as shown in Table 11. The three variations of the SV-5 are considered equivalent for the purposes of providing

information on OPERATIONAL NEEDS; likewise, the three versions of the OV-6 are considered equivalent for the purposes of providing information on SYSTEM REDUNDANCY.

The evaluation measures under the *System Effectiveness* branch look at how the system, as described by the architecture, meets the objectives of the instantiated system. The purpose being that the system has to 1) be the right system to meet those objectives and 2) be described in sufficient detail to show how it will meet those objectives. As a result, the views associated with most of the *System Effectiveness* evaluation measures need to identify specific attributes of the system that will address specific objectives and provide sufficient detail to show how it will address that objective. The following sections will discuss each measure result in more detail.

**Table 11. System Effectiveness Evaluation Measures by View Matrix**

MEASURES	Source Views												
	AV-1	OV-1	OV-2	OV-3	OV-4	OV-5	OV-6	SV-2	SV-5	SV-7	SV-8	SV-9	TV-1
Operational Needs	X	X		X		X			X	X			
Threat Detection		X		X		X							
Threat Assessment		X		X		X							
Warning Plan		X		X		X							
Technological Availability												X	
Environmental Impact													X
Monetary Practicality - Initial						X							
Monetary Practicality - Maintenance						X							
Adaptation											X		
Supportability Requirements										X			
Reliability Requirements										X			
System Redundancy							X						
Recoverability Requirements										X			
Joint Operations	X		X	X	X			X					
NESI Development													X
NESI Evaluation													X

#### **4.4.3.1. OPERATIONAL NEEDS**

Due to the wide range of possible operational needs that a system could be designed to address, the views required to describe how the system will meet those needs can vary. For the JFPASS, it was decided during the development of the evaluation measure that the AV-1, OV-1, OV-3, OV-5, SV-5, and SV-7 were the pertinent views for describing how the system would address OPERATIONAL NEEDS. The AV-1 provides the scope and purpose of the system. The three operational views describe the system functionality and show how those functions relate to OPERATIONAL NEEDS. The SV-5 connects the system functionality from the operational views to actual system components. The SV-7 identifies the level of performance that each system component needs to achieve to fully address the OPERATIONAL NEEDS. The strength of each of the six relationships for OPERATIONAL NEEDS was described as one divided by the total number of relationships or 0.167.

#### **4.4.3.2. THREAT DETECTION, THREAT ASSESSMENT, and WARNING PLAN**

Three of the key aspects of a joint force protection system are threat detection, threat assessment, and providing warning. These three aspects come from the detect, assess, warn, defend, and recover construct (Protection Assessment Branch, Joint Staff, 2004); for the JFPASS, it was decided to concentrate on the first three aspects of that construct. Similar to OPERATIONAL NEEDS, it was determined that the OV-1, OV-3, and OV-5 were the appropriate views to describe the system functionality, and how the system would address the three key concepts of detect, assess, and warn. Each view was given equally emphasis resulting in the strength of the relationship between view and measure being described as 0.333.

#### **4.4.3.3. TECHNOLOGICAL AVAILABILITY, ADAPTATION, and SYSTEM REDUNDANCY**

TECHNOLOGY AVAILABILITY simply looks at technology readiness levels. The DoDAF does not specifically call for technology readiness levels to be included in any particular view. The SV-9 describes all of the emerging and forecasted technology advancements that will impact the system; because of its focus on developing technologies, it was deemed the appropriate place for information pertaining to technology readiness levels. ADAPTATION falls under the value of FLEXIBILITY and measures how well the system adapts to changing threats and is associated with the SV-8. SYSTEM REDUNDANCY falls under the value of SURVIVABILITY, and measures the amount of redundancy in the system and is associated with the OV-6. These three measures are each related to only one architecture view; as a result, each the strength of those relationships is described as a one and the full weight of the measure is given to the corresponding view.

#### **4.4.3.4. ENVIRONMENTAL IMPACT, NESI DEVELOPMENT, and NESI EVALUATION**

ENVIRONMENTAL IMPACT, NESI DEVELOPMENT, and NESI EVALUATION are all concerned with compliance with guidance and regulation. They are all associated with the TV-1 and whether or not the appropriate regulations and guidance are listed there. All three of these views are related solely to the TV-1 with a description of one, which transfers the weight of all three measures to the TV-1.

#### **4.4.3.5. MONETARY PRACTICALITY – INITIAL and MAINTENANCE**

MONETARY PRACTICALITY – INITIAL compares the acquisition cost versus the budgeted amount. Similarly, MONETARY PRACTICALITY – MAINTENANCE compares the

operation and maintenance cost of the system with the amount budgeted for that purpose. The OV-5 allows for inclusion of costing data for activities. Developing costing data by operational activity, as opposed to system component, may not be the preferred method but it is the only one that the DoDAF was found to support. As a result of how the DoDAF supports costing efforts, MONETARY PRACTICALITY – INITIAL and MAINTENANCE are related with the OV-5.

#### **4.4.3.6. SUPPORTABILITY, RELIABILITY, and RECOVERABILITY REQUIREMENTS**

SUPPORTABILITY, RELIABILITY, and RECOVERABILITY REQUIREMENTS measure the values of *Supportability*, *Reliability*, and *Recoverability* respectively. Each of these three measures looks for the identification of appropriate system requirements in the SV-7. As a result, their relationship to the SV-7 is described as a one and the SV-7 is credited with the full weight of the three measures.

#### **4.4.3.7. JOINT OPERATIONS**

JOINT OPERATIONS measures the value of *Interchangeability* by verifying the extent to which the system described in the architecture accounts for the various services and fits them into a joint concept of operations. Accounting for all services begins with the AV-1 as it provides the architect with the ability to describe the scope and context of the architecture. The OV-2 describes how nodes from different services connect and the OV-3 elaborates on the attributes of the information passed between nodes. Both of these operational views are important for identifying the important nodes within each service and ensuring they are appropriately connected within the system. The OV-4 describes at a higher level how organizations will relate to each other and the roles they will fill in the

system. The roles each service and its subunits will fill are vitally important in accounting for all services. Lastly, the SV-2 is needed to ensure that the systems that are specific to each service are capable of communicating with each other and fulfilling the value of *Interchangeability*.

#### **4.5. Completed Matrix**

Once the matrix was completed, there were several views that were found to not be associated with any of the measures and therefore are not important to the decision-maker's values. These views were removed from the matrix. Not counting variations of the same view, for instance SV-4a and SV-4b, 9 views were removed from the matrix leaving a total of 13 views. Additionally, the non-discriminating measures can be removed as was described in Section 4.4.1. The removal of the non-associated views and non-discriminating measures leaves a matrix of 27 measures by 13 views; this is demonstrated by Table 12. The completed matrix is presented in Table 13. Each relationship was multiplied by the global weight for that measure, which is found along the left side of the matrix, and summed for each view to obtain a total score. The total score for each view is found at the bottom of the matrix. It should be noted that due to the subtraction of the non-discriminating measures from the analysis, the total of all the global weights for the VDEA measures is only 0.828.



**Table 12. Removal of Non-Discriminating Measures and Non-Associated Views**

MEASURE	AV-1	AV-2	OV-1	OV-2	OV-3	OV-4	OV-5	OV-6	OV-7	SV-1	SV-2	SV-3	SV-4	SV-5	SV-6	SV-7	SV-8	SV-9	SV-10	SV-11	TV-1	TV-2	
Access	x																						
Product Locatability	x																						
Document Protection	x																						
Access Control	x																						
File Management	x																						
File Format	x																						
Connections	x	x	x	x	x	x	x	x	x	x	x	x	x	x	x	x	x	x	x	x	x	x	x
Architecture Redundancy	x	x	x	x	x	x	x	x	x	x	x	x	x	x	x	x	x	x	x	x	x	x	x
Architecture Economy	x	x	x	x	x	x	x	x	x	x	x	x	x	x	x	x	x	x	x	x	x	x	x
OV Readability			x	x	x	x	x	x	x														
SV Readability										x	x	x	x	x	x	x	x	x	x	x	x		
Seale	x	x	x	x	x	x	x	x	x	x	x	x	x	x	x	x	x	x	x	x	x	x	x
Tool Format	x																						
Decomposition							x																
DoDAF Compliancy	x	x	x	x	x	x	x	x	x	x	x	x	x	x	x	x	x	x	x	x	x	x	x
Requirement Traceability															x								
Internal Consistency	x	x	x	x	x	x	x	x	x	x	x	x	x	x	x	x	x	x	x	x	x	x	x
External Consistency	x	x	x	x	x	x	x	x	x	x	x	x	x	x	x	x	x	x	x	x	x	x	x
SME Effectiveness	x																						
SME Involvement	x																						
Operational Needs	x		x		x		x								x		x						
Threat Detection			x		x		x																
Threat Assessment			x		x		x																
Warning Plan			x		x		x																
Technological Availability																				x			
Environmental Impact																							x
Monetary Practicality - Initial							x																
Monetary Practicality - Maintenance							x																
Adaptation																		x					
Supportability Requirements																	x						
Reliability Requirements																	x						
System Redundancy								x															
Recoverability Requirements																	x						
Joint Operations	x			x	x	x					x												
NESI Development																							x
NESI Evaluation																							x

**Table 13. Completed Evaluation Measure by View Matrix**

MEASURE	Measure Weight	AV-1	OV-1	OV-2	OV-3	OV-4	OV-5	OV-6	SV-2	SV-5	SV-7	SV-8	SV-9	TV-1
Access	0.022	1.000												
Product Locatability	0.011	1.000												
Document Protection	0.033	1.000												
Access Control	0.033	1.000												
File Management	0.021	1.000												
File Format	0.021	1.000												
Tool Format	0.012	1.000												
Decomposition	0.024						1.000							
Requirement Traceability	0.020								1.000					
SME Effectiveness	0.015	1.000												
SME Involvement	0.015	1.000												
Operational Needs	0.041	0.167	0.167		0.167		0.167			0.167	0.167			
Threat Detection	0.041		0.333		0.333		0.333							
Threat Assessment	0.041		0.333		0.333		0.333							
Warning Plan	0.041		0.333		0.333		0.333							
Technological	0.020												1.000	
Environmental Impact	0.020													1.000
Monetary Practicality - Initial	0.020						1.000							
Monetary Practicality - Maintenance	0.020						1.000							
Adaptation	0.027											1.000		
Supportability Requirements	0.035										1.000			
Reliability Requirements	0.064									1.000				
System Redundancy	0.040													
Recoverability Requirements	0.026												1.000	
Joint Operations	0.033	0.200		0.200	0.200	0.200								
NESI Development	0.066													1.000
NESI Evaluation	0.066													1.000
Weighted Total		0.1964	0.0478	0.0066	0.0544	0.0066	0.1118	0.0400	0.0066	0.0268	0.1318	0.0270	0.0200	0.1520

#### 4.5.1. View Analysis

Under previously stated assumptions, the score that each view receives is a comparative score of discriminating importance, meaning that a view with a larger score is more important than a view with a smaller score. A total of 13 views received a non-zero score, the ranking of these views in decreasing importance can be found in Table 14. These 13 views represent the most important views for the JFPASS project. These are the views that should be built to meet the overall objective of the JFPASS architecture. Of these 13 views, only nine are required by the Joint Capabilities Integration and Development System (JCIDS). The four views not required by the JCIDS are the OV-2, OV-3, SV-7, and SV-8. Additionally, two views required by the JCIDS, the SV-4 and the SV-6, are not important for achieving the objective of an architecture for the JFPASS. Three views that are required “as applicable” by the JCIDS are not required for a JFPASS architecture.

**Table 14. Rank Order of Most Important Views**

JCIDS			
Rank	View	Importance	Required
1	AV-1	0.1964	Yes
2	TV-1	0.1520	Yes
3	SV-7	0.1318	No
4	OV-5	0.1118	Yes
5	OV-3	0.0544	No
6	OV-1	0.0478	Yes
7	OV-6	0.0400	Yes
8	SV-8	0.0270	No
9	SV-5	0.0268	Yes
10	SV-9	0.0200	No
11	OV-2	0.0066	Yes
12	OV-4	0.0066	Yes
13	SV-2	0.0066	Yes

JCIDS Required Views Not Listed:  
SV-4, SV-6, SV-11, OV-7, TV-2

#### **4.5.2. Build Sequence Analysis**

The final phase of analysis is solving the network diagram from the DoDAF version 1 deskbook (2003) given the list of most important views. The objective of this analysis is to provide an ordered list for view creation that increases the usefulness of the architecture as quickly as possible while maintaining the advantages of following the network diagram. Figure 5 is a simplified version of the network diagram suggested in the DoDAF version 1 deskbook (2003). This simplified network diagram eliminates views that are not important to the JFPASS architecture and not a prerequisite for a view that is important to the architecture.

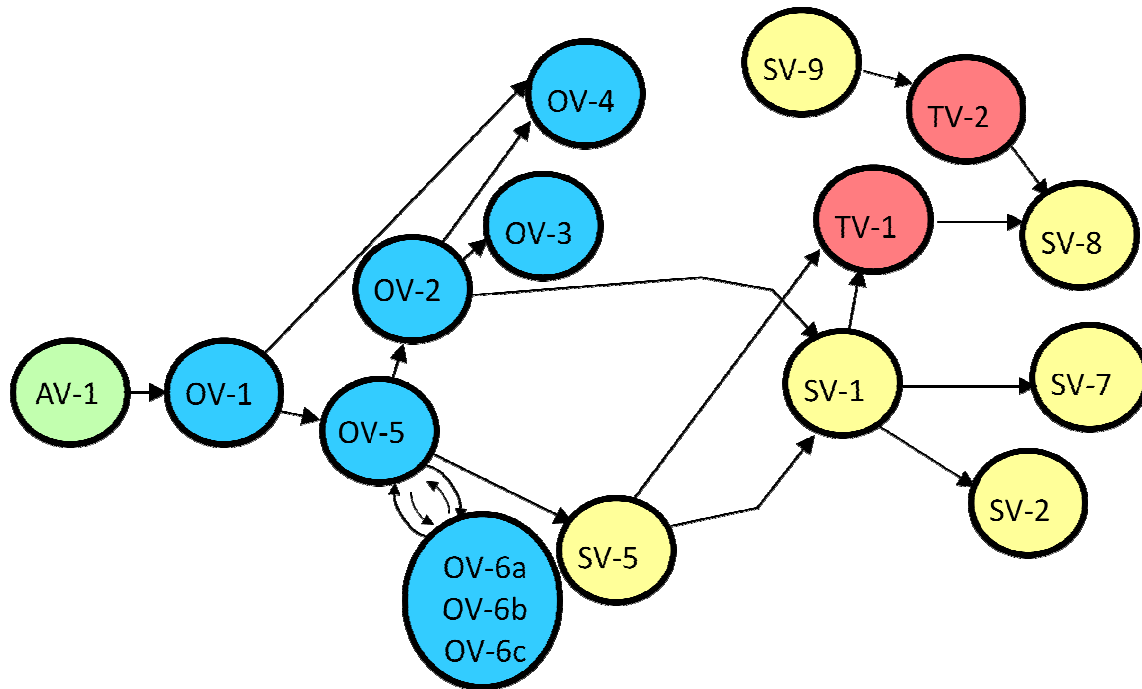

**Figure 5. Simplified Network Diagram for JFPASS Architecture**

The simplified network diagram includes 15 views, two more than the 13 views found to be important to a JFPASS architecture. The TV-2 is not required for any evaluation measure but is recommended for its relationship to the SV-8. The SV-1 is also not required for any evaluation measure; however, it is recommended for its usefulness in identifying technical standards for the TV-1, performance standards for the SV-7, and its relationship to the SV-2.

The first heuristic applied to the simplified network diagram was the “steepest ascent” heuristic, which selects views based on importance. For the purposes of this analysis, the SV-1 is considered the 14th most important view and the TV-2 the 15th most important view. The build sequence that this “steepest ascent” heuristic produced

resulted in both the TV-1 and SV-7, which were ranked second and third, respectively, being built late in the sequence. This is because one of the prerequisites for both of these views is the SV-1, which is ranked near the bottom of the views being considered. The resulting build sequence from this heuristic can be seen in Table 15.

**Table 15. Steepest Ascent Build Sequence**

# of Views	Steepest Ascent Heuristic		
	View	Added Importance	Cumulative Importance
1	AV-1	0.1964	0.1964
2	OV-1	0.0478	0.2442
3	OV-5	0.1118	0.3560
4	OV-6	0.0400	0.3960
5	SV-5	0.0268	0.4228
6	SV-9	0.0200	0.4428
7	OV-2	0.0066	0.4494
8	OV-3	0.0544	0.5038
9	OV-4	0.0066	0.5104
10	SV-1	0.0000	0.5104
11	TV-1	0.1520	0.6624
12	SV-7	0.1318	0.7942
13	SV-2	0.0066	0.8008
14	TV-2	0.0000	0.8008
15	SV-8	0.0270	0.8278

The “most successors” heuristic suggests the SV-1 earlier in the build sequence because of the number of successor views to the SV-1. This allows the TV-1 and SV-7 to move up in the build sequence but the SV-7 is delayed because it has no followers. The resulting build sequence from the application of this heuristic can be seen in Table 16.

**Table 16. Most Successors Build Sequence**

Most Critical Successors Heuristic				
# of Views	Solution	Number of Critical Successors	Added Importance	Cumulative Importance
1	AV-1	Critical	0.1964	0.1964
2	OV-1	3	0.0478	0.2442
3	OV-5	Critical	0.1118	0.3560
4	SV-5	2	0.0268	0.3828
5	OV-2	2	0.0066	0.3894
6	SV-1	2	0.0000	0.3894
7	TV-1	Critical	0.1520	0.5414
8	SV-7	Critical	0.1318	0.6732
9	OV-3	0	0.0544	0.7276
10	OV-6	0	0.0400	0.7676
11	SV-9	0	0.0200	0.7876
12	OV-4	0	0.0066	0.7942
13	SV-2	0	0.0066	0.8008
14	TV-2	0	0.0000	0.8008
15	SV-8	0	0.0270	0.8278

The final solution used the “most critical followers” heuristic. For this application, the top four views by importance ranking were designated as critical. The distinction was made between the fourth and fifth view because of the significant drop in

importance. This rule selects critical views first, views with the most critical followers second, and then views without critical followers in order of importance score third. This solution moved up the SV-1 because it has two critical followers and moved up the TV-1 and SV-7 because they are considered critical. This solution is shown in Table 17.

**Table 17. Most Critical Followers Heuristic**

# of Views	Most Successors Heuristic			
	Solution	Number of Successors	Added Importance	Cumulative Importance
1	AV-1	14	0.1964	0.1964
2	OV-1	13	0.0478	0.2442
3	OV-5	10	0.1118	0.3560
4	OV-2	7	0.0066	0.3626
5	SV-5	5	0.0268	0.3894
6	SV-1	4	0.0000	0.3894
7	SV-9	2	0.0200	0.4094
8	TV-1	1	0.1520	0.5614
9	TV-2	1	0.0000	0.5614
10	SV-7	0	0.1318	0.6932
11	OV-3	0	0.0544	0.7476
12	OV-6	0	0.0400	0.7876
13	SV-8	0	0.0270	0.8146
14	OV-4	0	0.0066	0.8212
15	SV-2	0	0.0066	0.8278

The SV-1 is a critical hinge point in the network due to the number of successors and the importance of those successors. The SV-1 itself does not add to the growth of the architecture but unlocks several key views that allow for rapid growth. The major



difference between the three solutions presented here is the placement of the SV-1 in the build sequence. Placing the SV-1 early in the build sequence sacrifices short term growth for long term growth as is the case with the “most critical followers” heuristic. All three solutions reach the same end point but have different levels of maturity at various points in development, as can be seen in Figure 6.

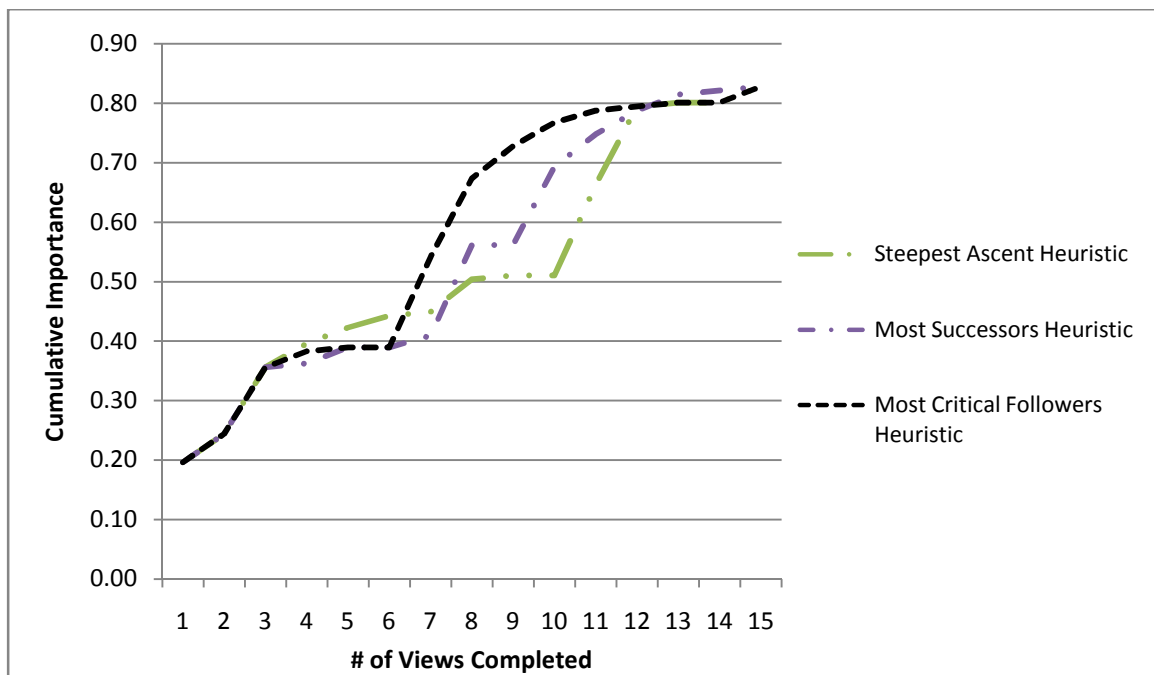

Figure 6. Cumulative Progress as a Function of Number of Completed Views

## Chapter 5. Conclusion

This research has presented a methodology to focus enterprise architecture view generation on the stated objectives of the architecture development project. The methodology balances values, identifies the views that are important to those values, and helps the program manager develop architecture in a logical manner. The methodology also answers several specific questions about the Department of Defense Architectural Framework (DoDAF) and the Joint Capabilities Integration and Development System (JCIDS) process, opening up avenues for future research that will assist in refocusing both the architectural framework and the system acquisition process on the creation of value.

### 5.1. Answers to Research Question

Aside from demonstrating a useful program management tool, this research sought to examine how both the DoDAF and the JCIDS contribute to meeting the overall objective of an architecture development project. This research answers questions about how the DoDAF views contribute to the Joint Force Protection Advanced Security System (JFPASS) architecture and how the JCIDS requirements compare with what is important to the JFPASS architecture. This section details the answers to each research question introduced in Chapter 1. The first two research questions focused on the importance of individual DoDAF views and how they contribute to the architecture. Questions three and four focused on the JCIDS requirements for architecture and how those requirements fit with the findings from questions one and two. The final question

demonstrated how the results of the methodology could be used to support decision making in an architecture development effort.

### 5.1.1. What DoDAF views are the most important to the JFPASS architecture?

The analysis of the results shows that there are 13 views that are more important than the other DoDAF views for the JFPASS architecture. All of the views described in the DoDAF have the potential of conveying useful information about a system; however, the 13 most important views listed in Table 18 are the ones best suited for conveying the information that subject matter experts and Security Equipment Integration Working Group (SEIWG) officials value most. Of these 13 views, the top four views are significantly more important than the remaining nine views.

**Table 18. The Most Important Views for the JFPASS**

Rank	View	Importance
1	AV-1	0.1964
2	TV-1	0.1520
3	SV-7	0.1318
4	OV-5	0.1118
5	OV-3	0.0544
6	OV-1	0.0478
7	OV-6	0.0400
8	SV-8	0.0270
9	SV-5	0.0268
10	SV-9	0.0200
11	OV-2	0.0066
12	OV-4	0.0066
13	SV-2	0.0066

The most important view to the JFPASS architecture is the AV-1; this view is 23% more important than the second most important view. The importance of the AV-1 stems in large part to its flexibility in conveying a wide variety of information to the potential users of an architecture. The ability of the AV-1 to identify the scope and purpose of the architecture provides useful information on how to interpret the other views. The AV-1 has the capability to list the people and offices involved in the creation of the architecture which, when used to describe the involvement of subject matter experts and stakeholders from across the four services, adds credibility to the architecture. The AV-1 can also provide potential users with information on gaining access to and using the architecture, such as any applicable protections and controls, formatting, and software tools. Given the powerful and flexible format of the AV-1 as an “executive summary” and “planning guide” (Department of Defense, 2007) for the creation of an architecture, it is not surprising that it was found to be extremely important for the JFPASS.

The second and third most important views to a JFPASS architecture are the TV-1 and the SV-7. The ability of the system to operate in a variety of environments and locations as well as interoperate with other services requires it to conform to a number of technical standards. Additionally, as with most systems, the JFPASS must meet a number of operational needs as well as be durable and easy to maintain. The simplest way to ensure that the system eventually meets technical and performance standards is to identify those standards as early and explicitly as possible. The TV-1 and SV-7 provide the architecture the capability of explicitly stating the technical and performance standards at the outset of the acquisition process.

The fourth most important view is the OV-5 Operational Activity Model. The purpose of any system is to fulfill an operational need by performing some task. How the system is to perform the task is important to the user and the designer. The OV-5 provides a format for detailing how the system will perform its given function and meet the operational need. Most of the importance of the OV-5 comes from its link to the measures under the value of *Purposefulness* and the relatively high weighting of that value. The OV-5 also gains some value under the two measures of monetary practicality as the only place in the DoDAF that supports the inclusion of costing data. Providing costing data by activity may not be ideal for all systems, and this may be an area that the DoDAF could be improved.

The remaining nine views from the top 13 account for approximately 28% of the total importance of the architecture. These nine views contribute significantly to the achievement of the overall objective for the architecture and should be created to ensure the full achievement of that overall objective. However, individually they do not warrant detailed discussion here.

### **5.1.2. What DoDAF views should be built based on the overall objective of the JFPASS architecture?**

An analysis of each evaluation measure showed that there were 13 views of greater importance than the other DoDAF views. These 13 views cover all of the evaluation measures being considered. Their ability to completely cover the evaluation measures means that these 13 views are capable of gaining full value for the JFPASS architecture when evaluated with the VDEA score. A sub-set of these 13 views may also be able to gain full value but no more than these 13 is required.

### **5.1.3. Which if any JCIDS required views are emphasized by the values associated with the JFPASS architecture?**

The JCIDS process requires the SV-4 and the SV-6 for both the Milestone B and Milestone C decision points. The OV-7, SV-11, and the TV-2 are required as applicable at different milestone decision points. None of these views was found particularly beneficial to a JFPASS architecture. This suggests some level of disconnect between the values of subject matter experts and the program office with the JCIDS process. This research is unable to examine the JCIDS process to identify the purpose of requiring these particular views, but these findings suggest it may be beneficial to examine JCIDS requirements and subject matter expert assumptions for architecture.

### **5.1.4. Which if any views that are important to the JFPASS architecture are not required by JCIDS?**

Four of the 13 views that were found to be important to a JFPASS architecture are not required for the JCIDS process. These views are the SV-7, OV-3, SV-8, and SV-9. The SV-7 is by far the most important of the four because of its ability to clearly lay out performance requirements for the system to be designed around. The SV-7 on its own accounts for approximately 16% of the importance of the 13 views; this represents a significant disconnect with the JCIDS. The remaining three views, OV-3, SV-8, and SV-9, account for approximately 12% of the importance of the 13 views, thereby making them an important combined contribution to the architecture. The JCIDS process does not require these views but also does not directly prohibit their creation either. However, by establishing a set of required views, the JCIDS process tends to drive a focus on the required views that may limit the resources available for the creation of non-required views.

**5.1.5. Based on the suggested network diagram from the DoDAF Deskbook (Department of Defense, 2003), in what order should the views be created to most rapidly increase the usefulness of the JFPASS Architecture?**

A simple heuristic for deciding the order in which to create the views is to simply create the most important view for which all prerequisite views have been created. The drawback to this “steepest ascent” approach is that the resulting build process can delay creation of low importance views with high importance successors. This can dramatically delay the creation of high importance views, as is the case with the application of the heuristic in this research. A better solution accounts for those higher importance views that are towards the end of the build sequence and can dramatically improve the resulting growth curve as seen in Figure 7. However, regardless of the exact order in which the views are created, if all 13 of the recommend views are created then the full value will be obtained. Both the relative importance of each view and the suggested network diagram are important tools for guiding architectural development. The program objectives for growth over time and resource constraints will determine which build sequence is most suitable. The selection of the most appropriate build sequence will also need to account for the number of views that can be created. If time or other resources constrain the total number of views that can be created, then the objective would be to optimize the solution for that number of views. For instance, if only nine views can be created under given funding constraints, then the “most critical followers” heuristic provides the best solution of the three examined here. If only five views can be created, then the “steepest ascent” heuristic provides the better solution.

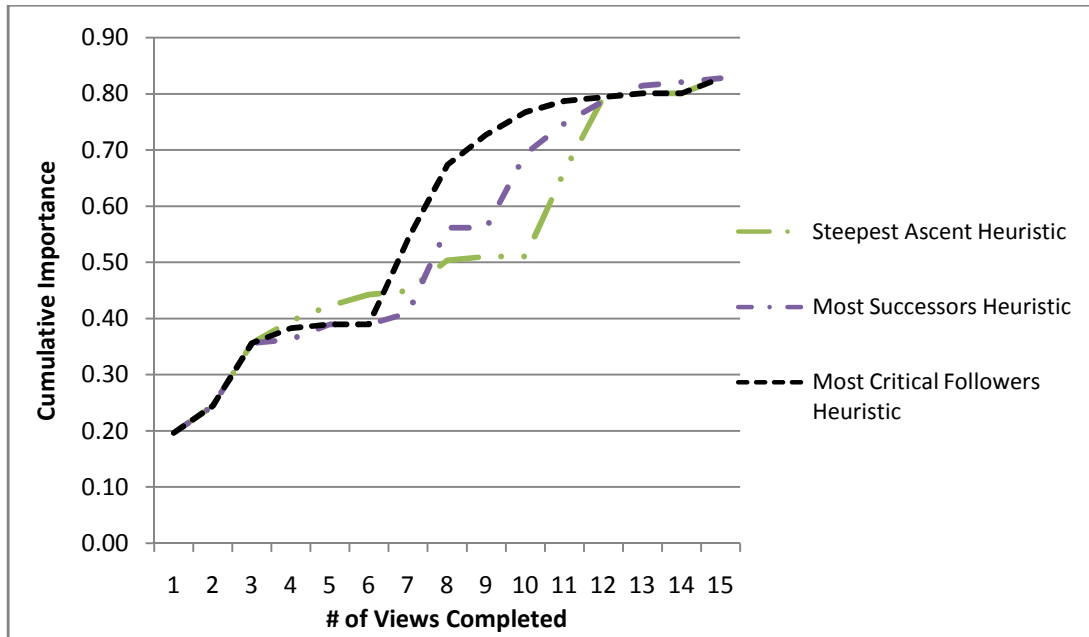

**Figure 7. Growth Curve Comparison**

In the case of the JFPASS, architecture view creation has already begun with a number of views having been created already. The VDEA score methodology was applied to the JFPASS views listed in Table 19 by Cotton and Haase (2009) and Mills (2009). In the case of an architecture project under development the build sequence analysis can still be applied. Views should still be created in the order prescribed by the chosen build sequence, if a view from the build sequence has already been created it should be evaluated using the VDEA score methodology and any deficiencies corrected. Based on the current status of the JFPASS architecture and the build sequence solution provided from the “most critical followers” heuristic, shown in Table 20, the next task for the JFPASS architecture is to revise the AV-1 followed by the OV-5, than architecture development can proceed in the order prescribed by the build sequence omitting any views already completed.



**Table 19. Completed JFPASS Views (Mills, 2009)**

AV-1	SV-1
OV-1	SV-2
OV-2	SV-4
OV-4	SV-6
OV-5	TV-1
OV-6c	

**Table 20. Most Critical Successors Heuristic with JFPASS Current Status**

Most Critical Successors Heuristic					
# of Views	Sequence	Number of Critical Successors	Added Importance	Cumulative Importance	JFPASS Current Status
1	AV-1	Critical	0.1964	0.1964	Draft, needs revision
2	OV-1	3	0.0478	0.2442	Complete
3	OV-5	Critical	0.1118	0.3560	Draft, needs revision
4	SV-5	2	0.0268	0.3828	None
5	OV-2	2	0.0066	0.3894	Complete
6	SV-1	2	0.0000	0.3894	Complete
7	TV-1	Critical	0.1520	0.5414	Complete
8	SV-7	Critical	0.1318	0.6732	None
9	OV-3	0	0.0544	0.7276	None
10	OV-6	0	0.0400	0.7676	Complete (OV-6c)
11	SV-9	0	0.0200	0.7876	None
12	OV-4	0	0.0066	0.7942	Complete
13	SV-2	0	0.0066	0.8008	Complete
14	TV-2	0	0.0000	0.8008	None
15	SV-8	0	0.0270	0.8278	None

### **5.3. Methodology Strengths**

The VDEA Development Goals (VDEA-DG) methodology provides a useful tool in planning and managing architecture development that focuses efforts the type and order of importance of architecture view development. In combination with the VDEA score, this methodology provides a comprehensive tool that explicitly identifies the architecture objectives, aids in selecting and prioritizing view creation, and tracks progress toward a complete value-driven architecture.

### **5.4. Methodology Weaknesses**

Though the methodology presented here holds great potential for further application in the management of architectural development, there are areas that need further refinement. The current process of linking views to value measures is not rigorously developed. The identification of views was discussed with subject matter experts in architecture and with SEIWG members in the context of scoring the architecture with the VDEA score. In future applications, this discussion should take place with an understanding of the impact it will have on view selection.

This research used the global weights of the evaluation measures and the linkage between measures and views as a proxy for the importance of each view. This methodology does not take into account the interdependency of views for meeting a measure or the ability of multiple views to convey the information necessary for a particular evaluation measure. As a result, the actual value gained by creating a view cannot be evaluated in order to create maximum value with a minimum number of views.

The methodology used to answer this research question assumed that no views had been previously developed, as in an architectural effort that has not yet begun. In the

case of the JFPASS, several views have already been built, in some cases without their prerequisites having been built. In a case such as this, it is recommended to build any missing prerequisites for views that have already been built and update the rest of the architecture as necessary. Then the build sequence can be solved for the remaining views.

### **5.5. Recommended Future Research**

Further research should explore the possibility of extending the methodology beyond the use as a proxy for importance and look specifically at the abilities of each view to generate value under different measures. This research should take into account the interdependencies of views and identify the value of single views and groups of views. This can be accomplished by considering the single dimensional value function (SDVF) when connecting views to measures. Inclusion of the SDVF will also allow the identification of the minimum views for creating full value. Additionally, the heuristics used for solving the build sequence are rudimentary and better approaches may exist. A methodology such as simulated annealing (Kirkpatrick, Gelatt, & Vecchi, 1983) or combinatorial optimization (Cook, Cunningham, Pulleyblank, & Schrijver, 1997) may be applied to better identify the optimal solution.

This research identified areas where the DoDAF lacks support for information areas that are of value to the JFPASS architecture program. The evaluation measures of MONETARY PRACTICALITY – INITIAL and MAINTENANCE required costing data for evaluating. After examining the DoDAF for references to costing data, the OV-5 was the only view found to support the inclusion of costing data and then simply as an activity cost estimate. MONETARY PRACTICALITY was found to be an important aspect of the

JFPASS that needed to be captured in the architecture. The importance of MONETARY PRACTICALITY seems logical, given the important role cost and budget play in decision-making. Further research should be done to find areas where the DoDAF can be refined and developed to improve support for valuable information by supporting areas of interest such as monetary practicality.

Concerns were also raised as to how the JCIDS requirements for architecture views could hinder creation of architecture views to meet the overall objective, as identified by the value hierarchy. Some disconnects were found between the JCIDS requirements and the views found to be important to the JFPASS architecture. The major finding was the absence of the SV-7 from the JCIDS requirements for milestone decisions. This view was found to be extremely important to the architecture and was linked to the values under maintainability, which was of particular interest to force protection experts. The identification of performance requirements is an important early step in designing any system and the SV-7 is designed for this purpose; its absence from the JCIDS and milestone decision making is surprising. The OV-3, SV-8, and SV-9 were also found to be important to the JFPASS architecture but are not included in the JCIDS requirements, whether these views would also be important to other architectures is difficult to assess. Further research into the JCIDS support for value-driven architecture by applying this methodology to other architecture projects would show what trends exist in values for architecture, the importance of individual views, and how the JCIDS requirements align with identified trends. This information could then be used to justify refinement of the JCIDS to allow view selection based on a value hierarchy.

## Bibliography

- Braziel, C. (2004). *Using Value-Focused Thinking to Evaluate the Effectiveness of Air Force Utility Privatization*. Wright-Patterson AFB: Air Force Institute of Technology.
- Bullock, R. K. (2006). *Theory of Effectiveness Measurement*. Wright-Patterson AFB: Air Force Institute of Technology.
- Burk, R. C., & Parnell, G. S. (1997). Evaluating Future Space Systems and Technologies. *Interfaces*, 27 (3), 60-73.
- Chairman of the Joint Chiefs of Staff. (2000). *Joint Vision 2020 America's Military: Preparing for Tomorrow*. Washington DC: Department of Defense.
- Chairman of the Joint Chiefs of Staff. (2004). *National Military Strategy of the United States of America*. Washington DC: Department of Defense.
- Chairman of the Joint Chiefs of Staff. (2007). *Operation of the Joint Capabilities Integration and Development System*. Washington DC: Department of Defense.
- Chambal, S. P. (2001). Class Notes, OPER 621, Multicriteria Decision Making. School of Engineering and Management. Air Force Institute of Technology, Wright-Patterson AFB.
- Cook, W. J., Cunningham, W. H., Pulleyblank, W. R., & Schrijver, A. (1997). *Combinatorial Optimization*. Hoboken: John Wiley & Sons.
- Cotton, L. D., Haase, G. A., Havlicek, J. D., & Thal, A. E. (2009). Value Driven Enterprise Architecture Score (VDEA-Score): A Means of DoDAF Architecture Evaluation. *7th Annual Conference on Systems Engineering Research*. Loughborough.
- Cotton, L., & Haase, G. (2009). *Value-Driven Enterprise Architecture Score: Evaluation of Joint Force Protection Future State Design*. Wright-Patterson AFB: Air Force Institute of Technology.
- Department of Defense. (2003). *Department of Defense Architectural Framework Version 1 Deskbook*. Washington DC: Department of Defense.
- Department of Defense. (2007). *Department of Defense Architectural Framework Version 1.5 Volume I*. Washington DC: Department of Defense.
- Department of Defense. (2007). *Department of Defense Architectural Framework Version 1.5 Volume II*. Washington : Department of Defense.

- Ford, T., Colombi, J., Graham, S., & Jacques, D. (2007). *The Interoperability Score*. Hoboken: 5th Annual Conference on Systems Engineering Research.
- Honour, E. (2004). *Understanding the Value of Systems Engineering*. Seattle: INCOSE.
- Institute For Enterprise Architecture Developments. (2007). *Enterprise Architecture Score Card, Institute For Enterprise Architecture Development (IFEAD)*. Retrieved January 14, 2009, from Institute For Enterprise Architecture Development (IFEAD): <http://enterprise-architecture.info/Images/Architecture%20Score%20Card/Architecture%20Score%20Card%20UK.htm>.
- Jones, R. D. (2006). *Assessing Resource Value and Relationships Between Objectives in Effects-Based Operations*. Wright-Patterson AFB: Air Force Institute of Technology.
- Jurk, D. M. (2002). *Decision Analysis with Value Focused Thinking as a Methodology to Select Force Protection Initiatives for Evaluation*. Wright-Patterson AFB: Air Force Institute of Technology.
- Kaplan, R. S., & Norton, D. P. (1996). *The Balanced Scorecard: Translating Strategy Into Action*. Boston: Harvard Business School Press.
- Kazman, R., Klein, M., & Clements, P. (2000). *ATAM: Method for Architecture Evaluation*. Pittsburgh: Carnegie Mellon Software Engineering Institute.
- Keeney, R. L. (1994). Creativity in Decision Making with Value-Focused Thinking. *Sloan Management Review*, 33-41.
- Keeney, R. L. (1992). *Value Focused Thinking: A path to Creative Decisionmaking*. Cambridge: Harvard University Press.
- Keeter, R. R., Parnell, G., & Goerger, S. R. (2005). *Applying Value-Focused Thinking to Effects Based Operations*. West Point: Operations Research Center of Excellence.
- Kirkpatrick, S., Gelatt, C. D., & Vecchi, M. P. (1983). Optimization by Simulated Annealing. *Science*, 671-680.
- Kirkwood, C. W. (1997). *Strategic Decision Making: Multiobjective Decision Analysis with Spreadsheets*. Cincinnati: Duxbury Press.
- Knighton, S. A. (1998). *A Value Focused Thinking Approach to Academic Course Scheduling*. Wright-Patterson AFB: Air Force Institute of Technology.
- Levis, A., Shin, I., & Bienvenu, M. (2000). C4ISR Architectures: III. An Object-Oriented Approach for Architecture Design. *Systems Engineering; Vol 3 No 4*, 288-312.

Levis, A., Wagenhals, L., Shin, I., & Kim, D. (2000). C4ISR Architectures: II. A Structured Analysis Approach for Architecture Design. *Systems Engineering; Vol 3 No 4*, 248-286.

Merideth, J. R., & Mantel, S. J. (2006). *Project Management A Managerial Approach*. Hoboken: John Wiley and Sons, Inc.

Mills, C. E., Osgood, J. W., Thal, A. E., & Havlicek, J. D. (2009). Assessing the Value of a Joint Force Protection System. *Proceedings of the Industrial Engineering Research Conference*. Miami.

Mills, C. (2009). *Value-Driven Enterprise Architecture Score for the Joint Force Protection Advanced Security System (JFPASS) System Effectiveness*. Wright-Patterson AFB: Air Force Institute of Technology.

Porter, M. E. (1992). Capital Disadvantage: America's Failing Capital Investment System. *Harvard Business Review*, 65-82.

Protection Assessment Branch, Joint Staff. (2004). *Department of Defense Protection Joint Functional Concept*. Washington DC: Department of Defense.

RAND Arroyo Center. (2006). *Assessing the Value of U.S. Army International Activities*. Santa Monica: RAND Corporation.

Shoviak, M. J. (2001). *Decision Analysis Methodology to Evaluate Integrated Solid Waste Management Alternatives for a Remote Alaskan Air Station*. Wright-Patterson AFB: Air Force Institute of Technology.

Tague, N. R. (2005). *The Quality Toolbox*. Milwaukee: ASQ Quality Press.

Tharaldson, M. K. (2006). *Strategic Airlift En Route Analysis to Support the Global War on Terrorism Using a Value Focused Thinking Approach*. Wright-Patterson AFB: Air Force Institute of Technology.

# REPORT DOCUMENTATION PAGE

*Form Approved*  
*OMB No. 074-0188*

The public reporting burden for this collection of information is estimated to average 1 hour per response, including the time for reviewing instructions, searching existing data sources, gathering and maintaining the data needed, and completing and reviewing the collection of information. Send comments regarding this burden estimate or any other aspect of the collection of information, including suggestions for reducing this burden to Department of Defense, Washington Headquarters Services, Directorate for Information Operations and Reports (0704-0188), 1215 Jefferson Davis Highway, Suite 1204, Arlington, VA 22202-4302. Respondents should be aware that notwithstanding any other provision of law, no person shall be subject to a penalty for failing to comply with a collection of information if it does not display a currently valid OMB control number.

**PLEASE DO NOT RETURN YOUR FORM TO THE ABOVE ADDRESS.**

<b>1. REPORT DATE (DD-MM-YYYY)</b> 13-03-2009		<b>2. REPORT TYPE</b> Master's Thesis		<b>3. DATES COVERED (From - To)</b> Jun 2008-Mar 2009	
<b>4. TITLE AND SUBTITLE</b> Methodology for Value-Driven Enterprise Architecture Development Goals: Application to DoDAF Framework				<b>5a. CONTRACT NUMBER</b>	
				<b>5b. GRANT NUMBER</b>	
				<b>5c. PROGRAM ELEMENT NUMBER</b>	
<b>6. AUTHOR(S)</b> Osgood, Justin, W. Capt USAF				<b>5d. PROJECT NUMBER</b> 09 ENV 274	
				<b>5e. TASK NUMBER</b>	
				<b>5f. WORK UNIT NUMBER</b>	
<b>7. PERFORMING ORGANIZATION NAMES(S) AND ADDRESS(S)</b> Air Force Institute of Technology Graduate School of Engineering and Management (AFIT/EN) 2950 Hobson Way WPAFB OH 45433-7765				<b>8. PERFORMING ORGANIZATION REPORT NUMBER</b> AFIT/GEM/ENV/09-M16	
<b>9. SPONSORING/MONITORING AGENCY NAME(S) AND ADDRESS(ES)</b> 642nd Electronic Systems Squadron 45 Arnold St. Bldg 1600 Hanscom AFB, Massachusetts 01731 781-377-1264				<b>10. SPONSOR/MONITOR'S ACRONYM(S)</b> 642 ELSS	
				<b>11. SPONSOR/MONITOR'S REPORT NUMBER(S)</b>	
<b>12. DISTRIBUTION/AVAILABILITY STATEMENT</b> APPROVED FOR PUBLIC RELEASE; DISTRIBUTION IS UNLIMITED.					
<b>13. SUPPLEMENTARY NOTES</b>					
<b>14. ABSTRACT</b> The Department of Defense Architectural Framework (DoDAF) describes 29 distinct views but offers limited guidance on view selection to meet system needs. This research extends the Value-Driven Enterprise Architecture Score (VDEA-Score) from a descriptive, evaluation protocol toward a prescriptive one by evaluating each DoDAF view and its contribution to the overall objective of the completed architecture. This extension of VDEA is referred to as VDEA-Development Goals (VDEA-DG). The program manager or other decision-makers may use this insight to justify the allocation of resources to the development of specific architecture views considered to provide maximum value. This research provides insight into the Joint Capabilities Integration and Development System (JCIDS) process and policy requirements. Existing guidance of a static list of views prior to DoD milestone approval detracts from the creation of vital architecture for system success. This research shows overlap between the most important views for the considered architecture project and the JCIDS requirements and identifies areas for JCIDS policy improvement. This research also identifies areas where DoDAF does not directly support the creation of capabilities. With additional information on the resources required for creating individual views, the tool could be expanded to identify an optimal build sequence given resource constraints.					
<b>15. SUBJECT TERMS</b> Enterprise Architecture, Value-Focused Thinking, Architecture Evaluation, DoDAF, JCIDS, Acquisition Reform, Value-Driven Architecture Evaluation, VDEA, Joint Force Protection, system acquisition, system engineering, program development, JFPASS, effectiveness measures, value hierarchy					
<b>16. SECURITY CLASSIFICATION OF:</b>			<b>17. LIMITATION OF ABSTRACT</b> UU	<b>18. NUMBER OF PAGES</b> 86	<b>19a. NAME OF RESPONSIBLE PERSON</b> Alfred E. Thal, Jr., PhD, ENV
<b>a. REPORT</b> U	<b>b. ABSTRACT</b> U	<b>c. THIS PAGE</b> U			<b>19b. TELEPHONE NUMBER (Include area code)</b> 937-255-3636

**Standard Form 298 (Rev. 8-98)**  
Prescribed by ANSI Std. Z39-18

*Form Approved*  
*OMB No. 074-0188*